

TERRAIN



DISCONTINUED

Terrain Rainwater Systems



Polypipe

PVC rainwater systems

Building Services



**TECHNICAL MANUAL
TERRAIN RAINWATER**



Terrain Rainwater

Distinctive shapes Exceptional performance

Quality product, innovation and outstanding service – the combined promise that ensures every one of the Terrain five rainwater drainage systems will surpass your requirements, whatever the installation you're specifying.

Large or small; residential or commercial; in the public sector or as part of an industrial development, in terms of both capacity and design aesthetics the Terrain range of products is impossible to beat.

Each Terrain system comprises fully integrated gutter and downpipe assemblies as well as outlets for balconies and flat roofs, and includes all the fittings and accessories needed for easy installation.

Features and benefits

- Captive seals in all gutter systems
- Combination clipping system for quick reliable installation
- Fixing locations positioned outside the wet areas
- Expansion markings on ALL gutter fixings
- Dry jointed spigot-socket downpipe system
- EN607/EN12200/EN1462 Approved

DISCONTINUED



Crescent

True half-round profile

Ideal for houses, smaller commercial buildings and offices. Can drain roof areas up to 122m² with a single downpipe. Capacity per outlet 2.54 litres/sec.*



Corniche

Square profile

A popular, modern system suiting domestic houses, bungalows and conservatories. Can drain roof areas up to 149m² with a single downpipe. Capacity per outlet 3.11 litres/sec.*



Streamline

Large square profile

A high capacity system ideal for commercial properties and larger houses. Can drain roof areas up to 294m² with a single downpipe. Capacity per outlet 6.11 litres/sec.*



Rapidflow

Deep elliptical profile

A high capacity system suiting all styles of property. Ideal for large roof areas or areas with higher than normal rainfall. Can drain roof areas up to 266m² with a single downpipe. Capacity per outlet 5.53 litres/sec.*



Omega

Ogee profile

Ideal for the more distinctive house, also suiting bungalows and conservatories. Can drain roof areas up to 242m² with a single downpipe. Capacity per outlet 5.04 litres/sec.*



Outlets

Roof and Balcony Outlets

Outlets available for all flat roof and balcony structures and drain vent systems (For large roof areas use Terrain Siphonics – see separate catalogue).

*For full capacity specifications please see System Planning on page 36.

Polypipe

Building Services

Contents

DISCONTINUED



Sustainable Materials

Terrain Drainage Products are 100% Lead Free.

Plastics are among the most researched materials in the world and rapid technological and manufacturing developments made in recent years have allowed for continuous innovation.

Terrain pioneered the development of PVC material for the manufacturing of drainage pipes and fittings; we remain at the forefront of the industry across the globe and are proud to be pioneering the industry once more with the development of our LEAD-FREE systems to minimise the environmental and health risk impacts of the PVC life cycle.

Utilising a lead-free material composition contributes significantly to an environmentally friendly manufacturing process and gives a finished product that is fully recyclable in accordance with International Standards.

For further information, please refer to www.polypipe.com

Terrain Rainwater

System Selector	4
Roof & Balcony Outlets	5 - 7
Rainwater Downpipes - Round	8 - 15
Rainwater Downpipes - Square	16 - 19
Crescent Gutter System	20 - 22
Streamline Gutter System	23 - 24
Rapidflow Gutter System	25 - 26
Omega Gutter System	27 - 28
Accessories	29 - 30
Fixing & Connections	31 - 34
System Planning	35
General Principles	36 - 37
Gutter Installation	38
Downpipe Installation	39 - 42
Roof & Balcony Outlet Installation	43 - 47
Roof Outlet Installation	48
Index	49 - 51
	52-53

The Polypipe logo features a stylized '@' symbol inside a circle, followed by the word 'Polypipe' in a large, bold, blue sans-serif font. Below the main logo, the text 'Building Services' is written in a smaller, blue sans-serif font.

System Selector

Gutters

	downpipe options	68mm round	62mm square	75mm square	82mm round	110mm round	key component options	stop end outlet	gutter angle 90°	gutter angle 120°	gutter angle 135°	gutter adaptors to	4" CI spigot	4" CI socket	4" Ogee CI spigot	4 1/2" Ogee CI socket	Other PVC-u Manufacturers	Marley Deepflow	colour	grey	black	white	rustic
2150 Crescent		●						●	●	●	●		●	●	●	●	●		●	●	●	●	
2250 Corniche		●	●					●	●	●	●				●	●	†		●	●	●	●	
2350 Streamline			●*	●	●	●		●			●						●†			●	●	●	
2450 Rapidflow		●			●			●	●	●	●						●	●†		●	●	●	
2550 Omega		●	●					●	●	●	●		●	●	●	●	●†			●	●	●	

NB other adaptors available on request

bracket fixings – available for side and top rafter fixing.

Rise and fall drive in brackets also available

*Adaptor required †Special fitting (Prefab)

DISCONTINUED

Downpipes

	gutter suitability	2150 Crescent	2250 Corniche	2350 Streamline	2450 Rapidflow	2550 Omega	key component options	92 1/2 bend	112 1/2 bend	112 1/2 long radius bend	135° bend	single branch	double branch	wall offset	pipe and fitting clip	drive-in pipe clip	adjustable pipe clip	colour	grey	black	white	rustic
68mm Round		●	●*					●	●	●	●	●	●		●	●	●	●	●	●	●	●
62mm Square			●	●				●	●	●	●	●	●		●	●	●	●	●	●	●	●
75mm Square				●				●	●	●	●	●	●		●	●	●	●	●	●	●	●
82mm Round				●	●	●		●	●	●	●	●	●		●	●	●	●	●	●	●	●
110mm Round				●				●	●	●	●	●	●		●	●	●	●	●	●	●	●



Building Services

Balcony & Roof Outlets

	downpipe options	68mm round	62mm square	75mm square	82mm round	110mm round	application	balconies	small balconies	porches	garages	flat roofs general	flat roofs combined	flat roofs inverted	surface finish compatibility	screed	asphalt	mineral felt	single layer plastic	general roof finish
BALCONY OUTLETS																				
2172.3 screed finish		●*	●*		●		●	●	●	●	●				●					
2174.3 asphalt finish		●*	●*		●		●	●	●	●	●					●				
ROOF OUTLETS																				
2171.3A inverted roof outlet					●	●								●						●
2171.34 vent pipe outlet						●							●			●				●
2181.3 domed (small)					●			●	●	●							●	●	●	
2171.3 domed (large)					●	●						●				●			●	
2180.3 small					●			●	●	●							●	●	●	
2170.3 large					●	●					●					●				

*With adaptor 2173.3.25

For large roof areas (over 1000m²) use Terrain Siphonic Roof Drainage Systems, please see separate catalogue.

Terrain Roof & Balcony Outlets

Terrain Roof Outlets

Outlets



Size (mm)	A	B	C	D	E	F	Code
FLAT ROOF OUTLET (LARGE) grey only -To drain surface water from flat roofs Suitable for most roof finishes							
82	67	25	496	89	6	43	2170.3
110	58	25	406	117	6	43	2170.4

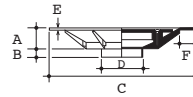

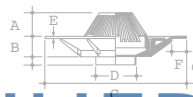

Size (mm)	A	B	C	D	E	F	G	Code
DOMED ROOF OUTLET (LARGE) grey only -To drain surface water from flat roofs Suitable for most roof finishes								
82	67	25	406	89	6	43	76	2171.3
110	58	25	406	117	6	43	76	2171.4

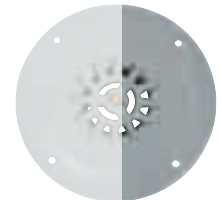
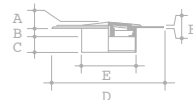

DISCONTINUED

Size (mm)	A	B	C	D	E	F	Code
FLAT ROOF OUTLET (SMALL DIAMETER) grey only -To drain surface water from porches, garages and small balconies. Suitable for mineral felt or single layer plastic roofs							
50	6	16	25	178	61	3	2180.2
82	6	16	25	178	87	3	2180.3



 **Polypipe**
Building Services

Size (mm)	A	B	C	D	E	F	Code
DOMED ROOF OUTLET (SMALL DIAMETER) grey only - To drain surface water from porches, garages and small balconies. Suitable for mineral felt or single layer plastic roofs							
50	48	16	25	178	61	3	2181.2
82	48	16	25	178	87	3	2181.3



Size (mm)	A	B	C	D	E	F	G	Code
INVERTED ROOF OUTLET grey only -To allow for drainage from two levels as required with inverted roof construction								
110	60	25	406	117	6	43	260	2174.4A



Size (mm)	A	B	C	D	E	F	G	Code
INVERTED ROOF OUTLET grey only -Special vented type for combined systems Suitable for most roof finishes								
110	58	25	406	117	6	43	371	2174.44

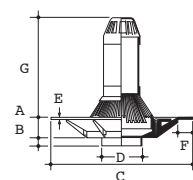

Terrain Roof & Balcony Outlets

Terrain Roof Outlets

Outlets

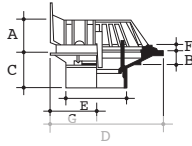

Size (mm)	A	B	C	D	E*	F	G	Code
-----------	---	---	---	---	----	---	---	------

BALCONY OUTLET grey only -For screed-finished balconies
 Connects to 82mm round downpipe can be reduced via socket Adaptors
 - 2173.3.25 for 68mm round pipe
 - 2273.3.23 for 62mm round pipe
 When used singly or at top of multi-storey building, use 9995.3 Blanking Cap
 * Min size hole for roof slab

82	48	27	59	170	94	13	68	2172.3
----	----	----	----	-----	----	----	----	--------

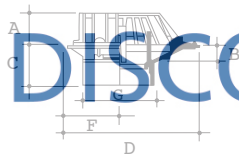
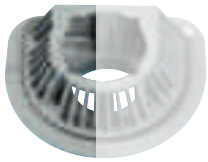

DISCONTINUED

Size (mm)	A	B	C	D	E*	F	G	Code
-----------	---	---	---	---	----	---	---	------

BALCONY OUTLET grey only -For asphalt-finished balconies
 Details as 2172.3 *Min size hole for roof slab

82	48	27	59	170	94	13	68	2174.3
----	----	----	----	-----	----	----	----	--------

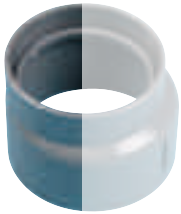

Size (mm)	A	B	L	Z	Code
-----------	---	---	---	---	------

SOCKET ADAPTOR (82MM X 68MM) grey only -To connect socket of 2172.3 and 2174.3 Balcony Outlets to 68mm round downpipe

82/68	82	68	60	45	2173.3.25
-------	----	----	----	----	-----------

Polypipe

Building Services

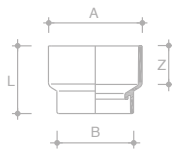
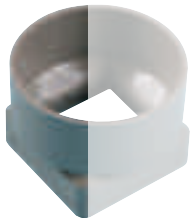

Size (mm)	A	B	L	Z	Colour	Code
-----------	---	---	---	---	--------	------

SOCKET ADAPTOR (82MM X 62MM) -To connect socket of 2172.3 and 2174.3 Balcony Outlets to 62mm square downpipe

82/62	82	62	60	45	W G	2273.3.25
-------	----	----	----	----	-----	-----------

Terrain Roof Outlets

Outlets



	Colour	Code
SPARE GRID FOR DOMED ROOF OUTLET -for 2171		
	G	9980

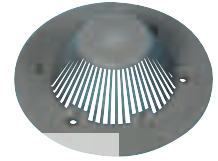

	Colour	Code
SPARE GRID FOR FLAT ROOF OUTLET -for 2170		
	G	9981



DISCONTINUED

	Colour	Code
SPARE GRID FOR BALCONY OUTLET -for 2172		
	G	9990



Polypipe

	Colour	Code
CAP FOR BALCONY OUTLET -For use with 2173.3.25 and 2273.23 when used singly or at top of multi-storey building		
	G	9995

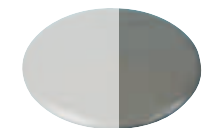

Building Services

Terrain Rainwater Downpipe Systems

Rainwater Downpipe System - 68mm

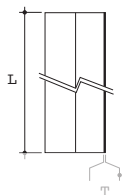

Size (mm)	L	T	Colour	Code
68MM DOWNPIPE - Plain ended lengths				
68	3.0m	1.8	W R B G	2100.25.30
68	4.0m	1.8	W R B G	2100.25.40
68	5.5m	1.8	W R B G	2100.25.55

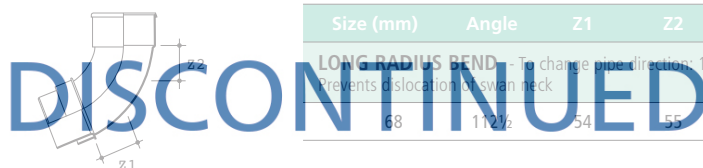

Size (mm)	Angle	Z1	Z2	Colour	Code
LONG RADIUS BEND - To change pipe direction: 112½° Prevents dislocation of swan neck					
68	112½	54	55	W R B	2101.25.112

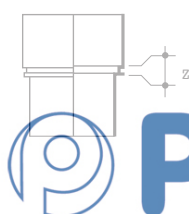

Size (mm)	Z	Colour	Code
STRAIGHT COUPLER - For joining pipe lengths. Fittings grooved to locate downpipe bracket			
68	8	W R G B	2107.25

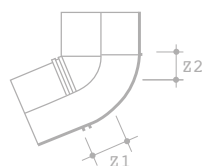

Size (mm)	Angle	Z1	Z2	Colour	Code
SHORT BEND - To change pipe direction: 92½° and 112½° bends To construct 'swan necks', use two 112½° bends					
68	92½	44	32	W R G B	2108.25.92
68	112½	32	22	W R G B	2108.25.112

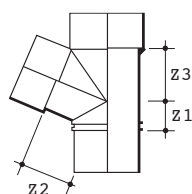

Size (mm)	Angle	Z1	Z2	Z3	Colour	Code
BRANCH - To join 68mm branch pipe to 68mm vertical pipe at an angle 90° and 112½°						
68	90	29	54	54	W R G B	2109.25.92
68	112½	29	54	54	W R G B	2109.25.112

Rainwater Downpipe System - 68mm

Size (mm)	A	B	C	D	E	F	G	H	Code
RAINWATER HEAD Colours: W R G B - To collect surface water at roof level where gutters are not possible									
68	250	140	66	273	38	179	44	64	2111.25

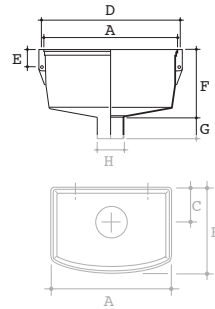

Size (mm)	A*	Colour	Code
PIPE AND FITTING BRACKET (ADJUSTABLE) - Allows up to 10mm stand-off adjustment. * A max = 73mm.			
68	63	W G B	2112.25.T

DISCONTINUED

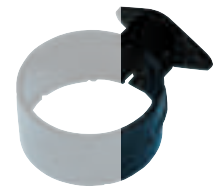
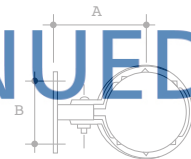

Size (mm)	A	Colour	Code
PIPE AND FITTING BRACKET (DRIVE-IN) - Minimum stand-off distance (to back of pipe): 52mm			
68	210	W B	2112.25.D



Polypipe

Building Services

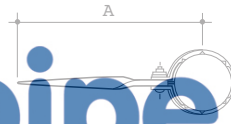

Size (mm)	A	B	C	Colour	Code
PIPE FITTING CLIP - Minimum stand-off distance (to back of pipe): 32mm					
68	66	90	110	W B	2113.25

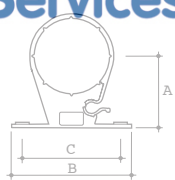

Size (mm)	A	B	Colour	Code
CENTRAL FIXING CLIP - Minimum stand-off distance (to back of pipe): 32mm				
68	70	40	W R B G	2113.25C

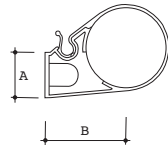

Terrain Rainwater Downpipe Systems

Rainwater Downpipe System - 68mm

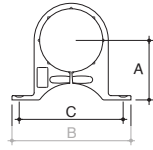

Size (mm)	A	B	C	Colour	Code
PIPE FITTING BRACKET - To secure downpipe to wall					
68	66	131	114	W R B G	2116.25



Size (mm)	Z1	Z2	Colour	Code
ACCESS PIPE - To allow pipe cleaning or inspection				
68	76	51	W R B G	2137.25

DISCONTINUED

 **Polypipe**
Building Services

Rainwater Downpipe Systems - 82mm

Size (mm)	L	Z	Colour	Code
82MM DOWNPIPE - Plain ended lengths				
82	4.0m	2	W R B	2100.3.40



Size (mm)	L	T(min)	Colour	Code
STRAIGHT COUPLER (DOUBLE SOCKET) - For joining pipe lengths				
82	92	3	W R B	2107.3

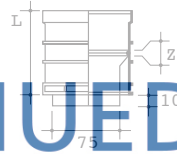

Size (mm)	Angle	Z1	Z2	Colour	Code
SWEPT BEND - To change pipe direction: 92½°, 112½° and 135° as standard To construct 'swan necks', use two 112½° bends					
82	92½	70	72	W R B	2101.3.92
82	112½	43	75	W R B	2101.3.112†
82	135	16	72	W R B	2101.3.135

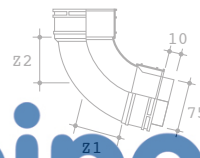

† Fabricated

Polypipe

Building Services

Size (mm)	Angle	Z1	Z2	Z3	Colour	Code
BRANCH (ALL SOCKET) - To join branch pipe to same size vertical pipe at an angle 92½°, 112½° and 135°						
82	92½	70	83	35	W R B	2109.3.92
82	112½	71	83	35	W R B	2109.3.112†

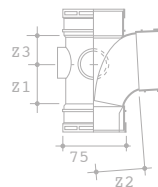

† Fabricated

Size (mm)	A	Z	Colour	Code
SHOE - To terminate rainwater downpipe discharging over gully				
82	64	86	W R B	2110.3

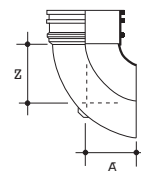

Terrain Rainwater Downpipe Systems

Rainwater Downpipe Systems - 82mm

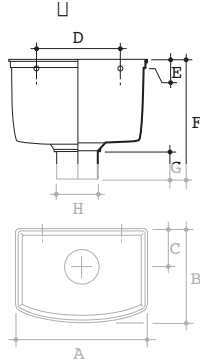

Size (mm)	A	B	C	D	E	F	G	H	Code
RAINWATER HEAD Colours: W R G B - To collect surface water at roof level where gutters are not possible									
82	254	180	75	153	15	222	51	75	2111.3

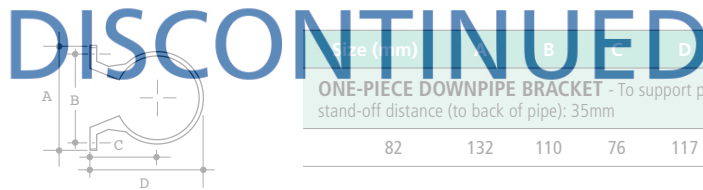

Size (mm)	A	B	C	D	Colour	Code
ONE-PIECE DOWNPIPE BRACKET - To support pipe and fittings – stand-off distance (to back of pipe): 35mm						
82	132	110	76	117	W R B	143.3

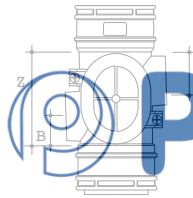

Size (mm)	A	B	Z	Colour	Code
ACCESS PIPE - To allow pipe cleaning or inspection					
82	41	39	120	W R B	2137.3

Polypipe

Building Services

Rainwater Downpipe Systems - 110mm

Size (mm)	L	T(min)	Colour	Code
110MM DOWNPIPE - Plain ended lengths				
110	3.0m	2.44	W B G	100.4.30
110	4.0m	2.44	W B G	100.4.40

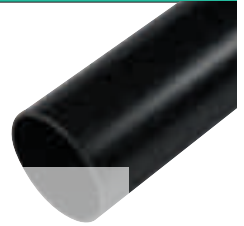
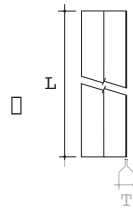

Size (mm)	L	Z1	Z2	Colour	Code
SWEPT BEND - To change pipe direction: 92½°, 112½° and 135° as standard					
110	92½	75	83	W B G	101.4.92
110	112½	65	63	W B G	101.4.112
110	135	30	30	W B G	101.4.135

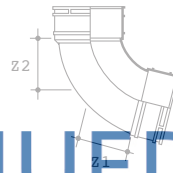

Size (mm)	Angle	Z1	Z2	Colour	Code
ACCESS BEND (DOUBLE SOCKET) - To allow pipe cleaning or inspection					
110	92½	102	98	W B G	103.4.92

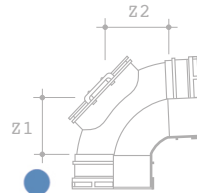

Size (mm)	Angle	Z1	Z2	Z3	Colour	Code
BRANCH (ALL SOCKET) - To join branch pipe to same size vertical pipe at an angle 92½° and 135°						
110	92½	82	82	54	W B G	104.4.92
110	135	25	137	137	W B G	104.4.135



Size (mm)	Angle	Z1	Z2	Z3	Colour	Code
ACCESS BRANCH - To allow pipe cleaning or inspection at junction of two pipes						
110	92½	99	96	50	W B G	105.4.92

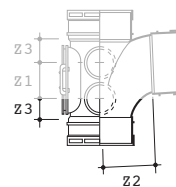

Size (mm)	Angle	Z1	Z2	Colour	Code
SPIGOT BEND - To change pipe direction in limited-space situation					
110	135	30	30	W B G	107.4.135

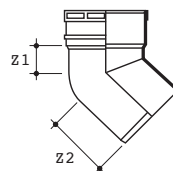

 **Polypipe**
Building Services

Terrain Rainwater Downpipe Systems

Rainwater Downpipe Systems - 110mm

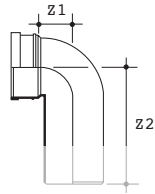

Size (mm)	Angle	Z1	Z2	Colour	Code
SPIGOT BEND (LONG TAIL) - To change pipe direction in limited-space situation					
110	92½	57	197	W B G	107.4.92



Size (mm)	L	Z	Colour	Code
STRAIGHT COUPLER - For joining pipe lengths				
110	102	3	W B G	110.4

DISCONTINUED



Size (mm)	L	Z	Colour	Code
EXPANSION COUPLER - To create expansion joint when joining pipe lengths in a solvent system				
110	123	3	W B G	111.4

Polypipe

Building Services

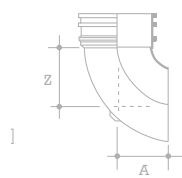

Size (mm)	A	Z	Colour	Code
SHOE - To terminate rainwater downpipe discharging over gully				
110	77	86	W B G	2110.4

Rainwater Downpipe Systems - 110mm

Size (mm)	L	Z	Colour	Code
ACCESS PIPE - To allow pipe cleaning or inspection				
110	216	115	W B G	138.4

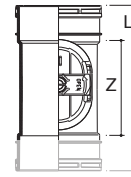

Size (mm)	L	Z	Colour	Code
ACCESS PIPE - To allow pipe cleaning or inspection				
110	216	166	W B G	139.4



DISCONTINUED

Size (mm)	A	B	C	D	Colour	Code
ONE-PIECE DOWNPIPE BRACKET - To support pipe and fittings – stand-off distance (to back of pipe): 35mm						
110	146	124	91	151	W B G	143.4

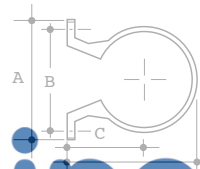

 **Polypipe**

Building Services

Terrain Rainwater Downpipe Systems

Rainwater Downpipe Systems - 62mm

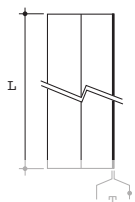

Size (mm)	L	T(min)	Colour	Code
DOWNPIPE - Plain ended lengths				
62	3.0m	1.8	W R B G	2200.23.30
62	4.0m	1.8	W R B G	2200.23.40
62	5.5m	1.8	W R B G	2200.23.55

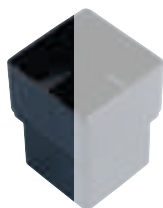

Size (mm)	Z	Colour	Code
STRAIGHT CONNECTOR - For joining pipe lengths			
62	6	W R B G	2207.23

DISCONTINUED

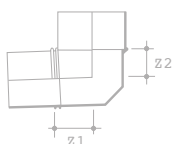
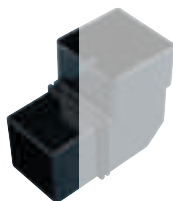

Size (mm)	Angle	Z1	Z2	Colour	Code
BEND - To change pipe direction: 92½° and 112½° bends as standard To construct 'swan necks', use two 112½° bends					
62	92½	30	40	W R B G	2208.23.92
62	112½	24	32	W R B G	2208.23.112

Polypipe

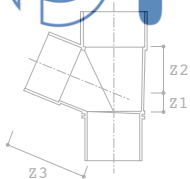

Size (mm)	Angle	Z1	Z2	Z3	Colour	Code
BRANCH - To join 62mm branch pipe to 62mm vertical pipe at an angle 112½°						
62	112½	31	46	57	W R B G	2209.23.112

Building Services

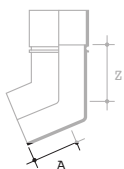

Size (mm)	A	Z	Colour	Code
SHOE - To terminate rainwater downpipe discharging over gully				
62	51	64	W R B G	2210.23

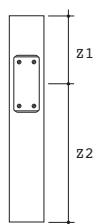

Size (mm)	Z1	Z2	Colour	Code
ACCESS PIPE - To allow pipe cleaning or inspection				
62	150	300	W R B	2237.23

Rainwater Downpipe Systems - 62mm

Size (mm)	A	B	C	D	E	F	G	H	Code
RAINWATER HEAD - To collect surface water at roof level where gutters are not possible. Available colours W R B G									
62	274	128	44	295	38	179	44	58	2211.23

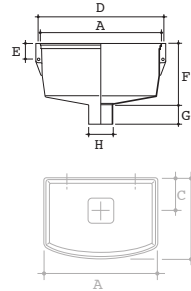

Size (mm)	A*	B	C	Colour	Code
PIPE AND FITTING BRACKET (ADJUSTABLE) - Allows up to 32mm stand-off adjustment. *A max = 70mm					
62	42	102	126	W R B G	2212.23

DISCONTINUED

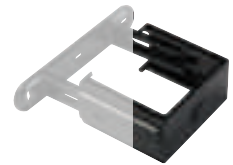
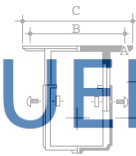

Size (mm)	A	B	C	Colour	Code
PIPE AND FITTING BRACKET (ADJUSTABLE) - Allows up to 32mm stand-off adjustment					
62	44	111	127	W R B G	2213.23

Polypipe

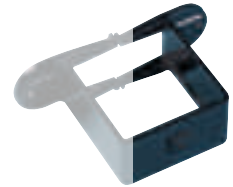
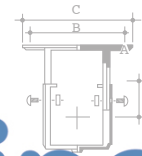

Size (mm)	A	B	C	Colour	Code
LONG STAND-OFF DOWNPIPE BRACKET - Allows up to 32mm stand-off adjustment					
62	62	93	109	W R B G	2216.23

Building Services

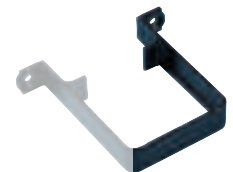
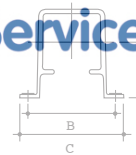

Size (mm)	A	Z	Colour	Code
WALL OFFSET - To allow downpipe to accommodate wall plinth or other obstruction up to 57mm				
110	57	22	W R B G	2214.23

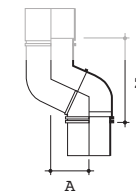

Size (mm)	Z	Colour	Code
ADAPTOR (SQUARE TO ROUND) - For connecting 62mm square to 68mm round down pipe			
62/68	24	W R B G	2215.23.25

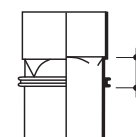

Terrain Rainwater Downpipe Systems

Streamline Rainwater Systems Downpipe - 75mm

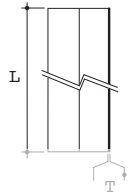
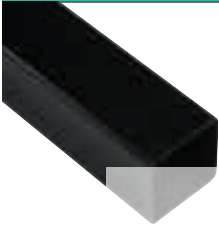

Size (mm)	L	T(min)	Colour	Code
DOWNPIPE - Plain ended lengths				
75	4.0m	2	W R B	2300.33.40

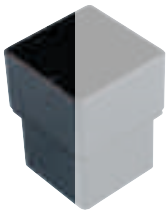

Size (mm)	Z	Colour	Code
STRAIGHT CONNECTOR - For joining pipe lengths			
75	8	W R B	2307.33

DISCONTINUED

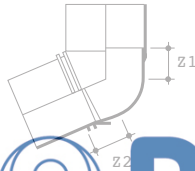

Size (mm)	Angle°	Z1	Z2	Colour	Code
BEND - To change pipe direction: 112½° bends To construct 'swan necks', use two 112½° bends					
75	112½	29	36	W R B	2308.33.112



Polypipe

Size (mm)	Dimensions	Colour	Code
3X3"SQ S/LINE BEND			
75	Fabricated	W R B	S2308.33.92

Building Services

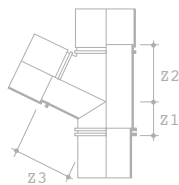

Size (mm)	Angle°	Z1	Z2	Z3	Colour	Code
BRANCH - To join 75mm branch pipe to 75mm vertical pipe at an angle 112½°						
75	112½	48	65	67	W R B	2309.33.112

Size (mm)	Dimensions	Colour	Code
3X3"SQ S/LINE BRANCH			
75	Fabricated	W R B	S2309.33.92

Streamline Rainwater Systems Downpipe - 75mm

Size (mm)	A	Z	Colour	Code
SHOE - To terminate rainwater downpipe discharging over gully				
75	55	68	W R B	2310.33

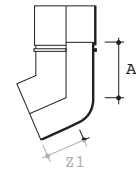

Size (mm)	A	B	C	D	E	F	G	H	Code
RAINWATER HEAD Colours: W R B - To collect surface water at roof level where gutters are not possible									
75	253	180	75	153	15	234	45	70	2311.33

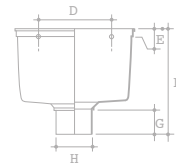

DISCONTINUED

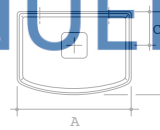

Size (mm)	A	B	C	Colour	Code
PIPE AND FITTING BRACKET - Stand-off distance (to back of pipe): 13mm					
75	50	124	140	W R B	2313.33

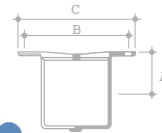

Polypipe

Size (mm)	A	Z	Colour	Code
WALL OFFSET - To allow downpipe to accommodate wall plinth or other obstruction up to 57mm				
75	57	127	W R B	2314.23

Building Services



Size (mm)	Z	Colour	Code
ADAPTOR (SQUARE TO SQUARE) - To adapt 2353.6.33 Running Outlet/Pipe to discharge into 2200 Downpipe (62mm square)			
75/62	16	W R B	2315.33.23

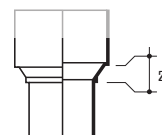

Size (mm)	Z1	Z2	Colour	Code
ACCESS PIPE - To allow pipe cleaning or inspection				
75	150	300	W R B	2337.33

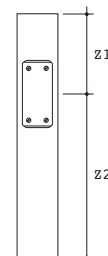

Terrain Crescent System

Crescent Rainwater Systems - 110mm

Crescent

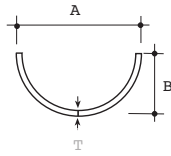

Size (mm)	A	B	T	Colour	Code
CRESCENT GUTTER - True half round profile for maximum capacity Standard gutter length 4m					
110	110	55	2.2	W R B G	2150.4.40

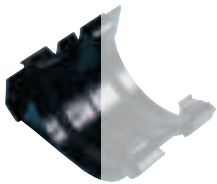

Size (mm)	A	Z	Colour	Code
JOINT BRACKET - For joining gutter lengths				
110	117	15	W R B G	2151.4

DISCONTINUED

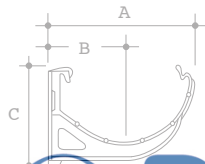

Size (mm)	A	B	C	Colour	Code
SUPPORTING BRACKET - For supporting gutter lengths, angles and stop-end outlets					
110	126	66	83	W R B G	2152.4

Polypipe

Building Services

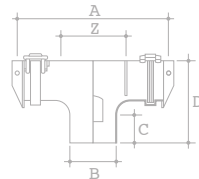

Size (mm)	A	B	C	D	Z	Colour	Code
RUNNING OUTLET - For connecting gutter run to downpipe							
110	214	68	35	117	95	W R B G	2153.4.25

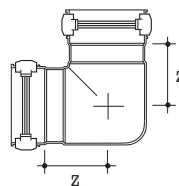
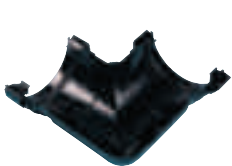



Size (mm)	Angle	Z	Colour	Code
GUTTER ANGLE - To change gutter run direction: 90°, 120° and 135° as standard				
110	90	88	W R B G	2154.4.90
110	120	60	W R B G	2154.4.120
110	135	54	W R B G	2154.4.135
110	156	96	W R B G	2154.4.156

Crescent Rainwater Systems - 110mm

Crescent 

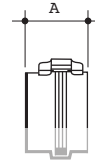
Size (mm)	A	Colour	Code
SHORT STOP-END - To cap open gutter end			
110	43	W R B G 	2155.4



Size (mm)	A	Colour	Code
INTERNAL STOP-END - To cap open gutter end			
110	33	B 	2156.4



DISCONTINUED

Size (mm)	A	B	C	D	Z	Colour	Code
STOP END OUTLET - To cap open gutter and connect gutter run to downpipe.							
110	145	68	35	117	84	W R B G 	2157.4.25

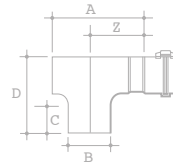

Polypipe

Size (mm)	Colour	Code
ADAPTOR TO OTHER PVC-U GUTTERS - 2100 adaptor to all round rainwater systems		
110	Self coloured	2158

Building Services



Size (mm)	A	B	Colour	Code
CRESCENT TO 4½" CAST IRON SPIGOT - Socket adaptor to receive spigot end of half-round cast iron gutter				
110	57	22	B G	2158.4.45

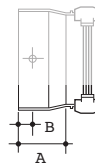

Size (mm)	A	B	Colour	Code
CRESCENT TO 4½" CAST IRON SOCKET - Spigot-end adaptor for linking into socket-end of half-round cast iron gutter				
110	57	19	B G	2159.4.45

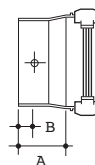

Terrain Crescent System

Crescent Rainwater Systems - 110mm

Crescent

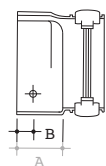
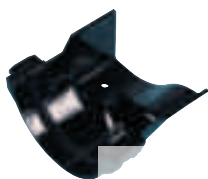

Size (mm)	A	B	Colour	Code
CRESCENT TO 4½" OGEE CAST IRON SPIGOT - Socket adaptor to receive spigot end of ogee cast iron gutter				
110	62	22	W R G B	2168.4.45

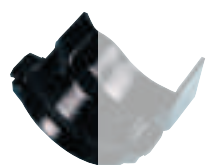

Size (mm)	A	B	Colour	Code
CRESCENT TO 4½" OGEE CAST IRON SOCKET - Spigot-end adaptor for linking into socket-end of ogee cast iron gutter				
110	62	22	B	2169.4.45



DISCONTINUED

Polypipe
Building Services

Terrain Corniche System

Corniche Rainwater Systems

Corniche 

Size (mm)	A	B	T	Colour	Code
CORNICHE GUTTER - Rectilinear profile Standard gutter length 4m					
	120	120	51	2.2	WRBG  2250.5.40

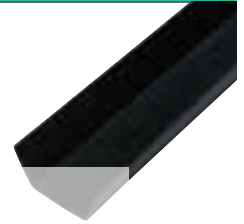
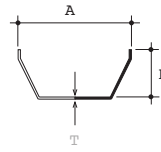

Size (mm)	A	Z	Colour	Code
JOINT BRACKET - For joining gutter lengths				
120	114	1.4	WRBG 	2251.5

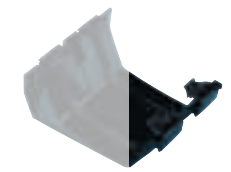
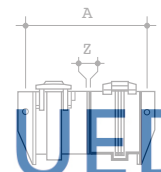

DISCONTINUED

Size (mm)	A	B	C	Colour	Code
SUPPORT BRACKET - For supporting gutter lengths, angles and stop-end outlets					
120	134	71	81	WRBG 	2252.5

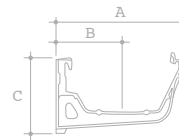

 **Polypipe**

Size (mm)	A	B	C	D	Z	Colour	Code
RUNNING OUTLET - For connecting gutter run to downpipe							
110	193	62	44	105	75	WRBG 	2253.5.2

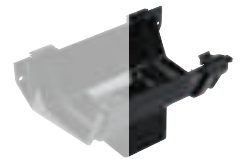
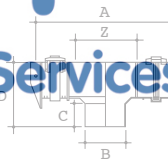



Building Services

Terrain Corniche System

Corniche Rainwater Systems

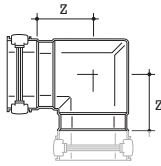
Corniche 



Size (mm)	Angle	Z	Colour	Code
GUTTER ANGLE - To change gutter run direction: 90°, 120° and 135° as standard				
120	90	95	W R G B	 2254.5.90
120	120	61	W R G B	2254.5.120
120	135	55	W R G B	2254.5.135

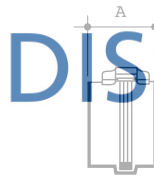
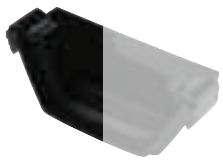

DISCONTINUED

Size (mm)	A	Colour	Code
SHORT STOP-END - To cap open gutter end			
120	43	W R G B	 2255.5

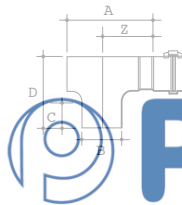
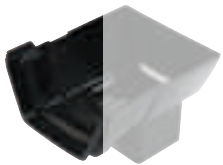



Size (mm)	A	B	C	D	Z	Colour	Code
STOP-END OUTLET - To cap open gutter end and connect gutter to downpipe							
120	106	62	44	106	65	W R G B	 2257.5.23

Polypipe
Building Services

Terrain Streamline System

Streamline Rainwater Systems - 137mm

Streamline 

Size (mm)	A	B	T	Colour	Code
STREAMLINE GUTTER - High capacity rectilinear profile. Standard gutter length 4m					
 137	137	73	2.5	W R B	 2350.6.40

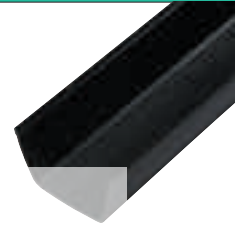
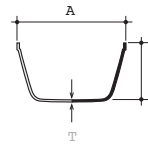

Size (mm)	A	Z	Colour	Code
JOINT BRACKET - For joining gutter lengths				
137	149	2	W R B	 2351.6.12

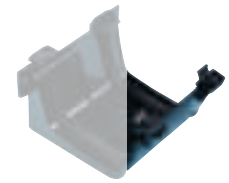
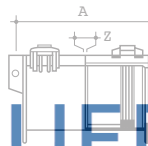



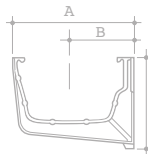

DISCONTINUED

Size (mm)	A	B	C	Colour	Code
SUPPORT BRACKET - For supporting gutter lengths					
137	153	82	115	W R B	 2352.6

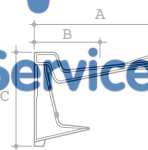

Size (mm)	A	B	C	Colour	Code
OVERSLUNG BRACKET - Leaves front face of gutter uncluttered for improved appearance					
137	162	82	114	W R B	 2353.6.10



Size (mm)	A	B	C	D	Z	Colour	Code
RUNNING OUTLET - For connecting gutter run to downpipe							
To 75mm square downpipe							
137	281	75	45	157	133	W R B	 2353.6.33
To 82mm round downpipe							
137	281	75	50	174	133	W R B	 2353.6.3
To 110mm round downpipe							
137	281	103	50	157	133	W R B	 2353.6.4

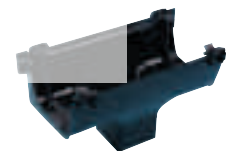
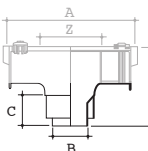



 **Polypipe**
Building Services

Terrain Streamline System

Streamline Rainwater Systems - 137mm

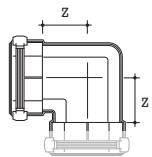
Streamline 



Size (mm)	Angle°	Z	Colour	Code
GUTTER ANGLE - To change gutter run direction: 90° and 135° as standard				
137	90	85	W R B	 2354.6.90
137	135	40	W R B	2354.6.135

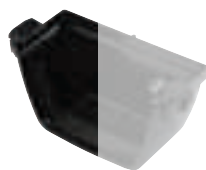

DISCONTINUED

Size (mm)	A	Colour	Code
SHORT STOP-END - To cap open gutter end			
137	71	W R B	 2355.6

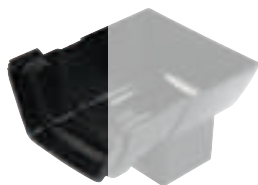

Polypipe

Size (mm)	Dimensions	Colour	Code
STREAMLINE STOP END OUTLET LEFT HAND			
137	Fabricated	W R B	 2357.6.33WLH

Size (mm)	Dimensions	Colour	Code
STREAMLINE STOP END OUTLET RIGHT HAND			
137	Fabricated	W R B	 2357.6.33WRH

Building Services

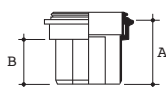
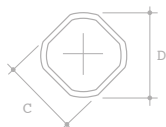



Size (mm)	A	B	C	D	Colour	Code
SCREWED OUTLET ADAPTOR - Spigot outlet to be set into gutter base Allows connection to 75mm square downpipe. *Use 75mm hole cutter						
75	68	45	70	75	W R B	2368.3

Terrain Rapidflow System

Rapidflow Rainwater Systems - 131mm

Rapidflow 

Size (mm)	A	B	T	Colour	Code
RAPIDFLOW GUTTER - Deep elliptical profile. Standard gutter length 4m					
 131	131	82	2.5	W R B	 2450.5.40

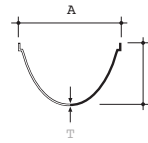

Size (mm)	A	Z	Colour	Code
JOINT BRACKET - For joining gutter lengths				
131	115	1.5	W R B	 2451.5

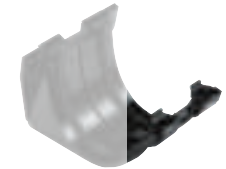
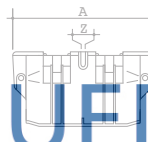

DISCONTINUED

Size (mm)	A	B	C	Colour	Code
SUPPORT BRACKET - For supporting gutter lengths, angles and stop-end outlets					
131	145	76	115	W R B	 2452.5

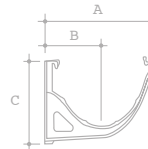

 **Polypipe**

Size (mm)	A	B	C	D	Z	Colour	Code
RUNNING OUTLET - For connecting gutter run to downpipe							
To 68mm round downpipe							
131	266	68	35	188	144	W R B	 2453.5.2
To 82mm round downpipe							
131	266	82	45	188	144	W R B	2453.5.3

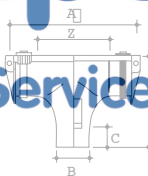

Building Services

Size (mm)	Angle°	Z	Colour	Code
GUTTER ANGLE - To change gutter run direction: 90° and 135° as standard				
131	90	109	W R B	 2454.5.90
131	135	63	W R B	2454.5.135

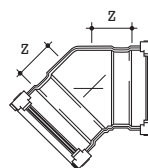

Terrain Rapidflow System

Rapidflow Rainwater Systems - 131mm

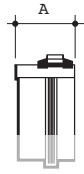

Rapidflow 

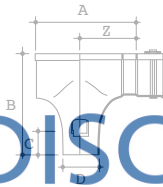
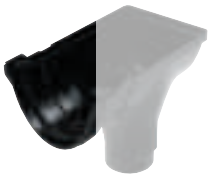

Size (mm)	A	Colour	Code
SHORT STOP-END - To cap open gutter end			
131	53	W R B	 2455.5



DISCONTINUED

Size (mm)	A	B	C	D	Z	Colour	Code
STOP-END OUTLET - To cap open gutter end and connect gutter to 68mm round downpipe							
131	183	188	35	68	99	W R B	 2457.5.25
STOP-END OUTLET - To cap open gutter end and connect gutter to 82mm round downpipe							
131	183	188	35	68	99	W R B	 2457.5.3





Size (mm)	Colour	Code
ADAPTOR CLIP TO OTHER PVC-U GUTTERS - 2400 adaptor to all deepflow round systems		
131	Self coloured	2467

 **Polypipe**
Building Services

Terrain Omega System

Omega Rainwater Systems - 122mm

Omega 

Size (mm)	A	B	T	Colour	Code
OMEGA GUTTER - Deep ogee profile. Standard gutter length 4m					
 122	122	72	2.5	W R B	 2550.5.40

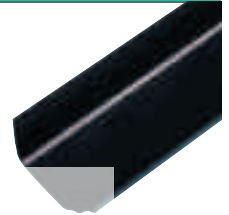
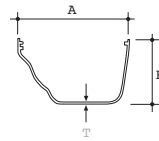

Size (mm)	A	Z	Colour	Code
JOINT BRACKET - For joining gutter lengths				
122	137	2.0	W R B	 2551.5

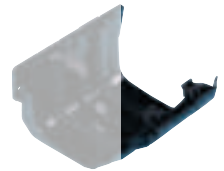
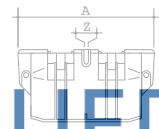

DISCONTINUED

Size (mm)	A	B	C	Colour	Code
UNDERSLUNG SUPPORT BRACKET - For supporting gutter lengths					
122	138	70	104	W R B	 2552.5C

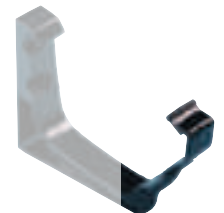
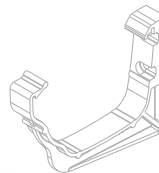

2552.5 is for use with Rafter brackets

122	138	70	104	W R B	 2552.5
-----	-----	----	-----	-------	--



Polypipe

Building Services

Size (mm)	A	B	C	Colour	Code
OVERSLUNG SUPPORT BRACKET - Leaves front face of gutter uncluttered for improved appearance					
122	142	70	76	W R B	 2552.5.150

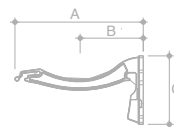

Size (mm)	A	B	C	D	Z	Colour	Code
RUNNING OUTLET - For connecting gutter run to 68mm or 62mm downpipe							
122	261	62	41	156	125	W R B	 2553.5.25

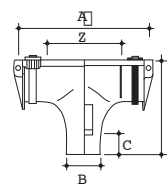

Terrain Omega System

Omega Rainwater Systems - 122mm

Omega 

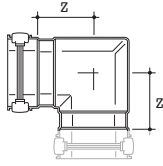

Size (mm)	Angle°	Z	Colour	Code
INTERNAL GUTTER ANGLE - To change gutter run direction: 90° and 135° as standard				
122	90	93	W R B	 2554.5.90I
122	135	27	W R B	2554.5.135I

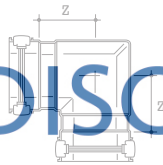
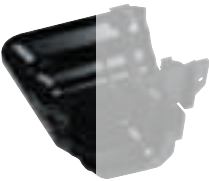

DISCONTINUED

Size (mm)	Angle°	Z	Colour	Code
EXTERNAL GUTTER ANGLE - To change gutter run direction: 90° & 135° as standard				
122	90	67	W R B	 2554.5.90E
122	135	23	W R B	2554.5.135E

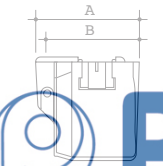
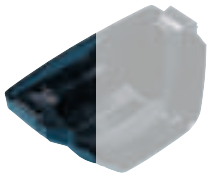

Size (mm)	A	B	Colour	Code
SHORT STOP-END (EXTERNAL) - To cap open gutter end at external roofline boundaries. Left (L) and Right (R) hand versions are available				
122	83	75	W R B	 2555.5L
122	83	75	W R B	 2555.5R

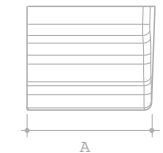
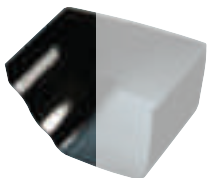

 **Polypipe**

Building Services

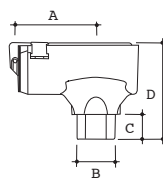
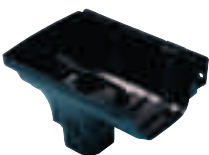

Size (mm)	A	Colour	Code
INTERNAL STOP-END - To cap open fitting end and at internal roofline boundaries. Left (L) and Right (R) hand versions are available			
122	120	W R B	 2556.5L
122	120	W R B	 2556.5R



Size (mm)	A	B	C	D	Colour	Code
STOP-END OUTLET - To cap open gutter end and connect gutter to 68mm or 62mm downpipe. Left (L) and Right (R) hand versions are available						
122	120	62	41	156	W R B	 2557.5.25L
122	120	62	41	156	W R B	 2557.5.25R

Rainwater Accessories

Rainwater Accessories

Size (mm)	A	B	C (min)	C (max)	D	Colour	Code
SIDE RAFTER BRACKET (ADJUSTABLE) - For connecting gutter support bracket and strap to side of open rafter end.							
For 2100 Crescent and 2200 Corniche							
	91	157	13	53	19	Self	2160
For 2300 Streamline, 2400 Rapidflow and 2500 Omega							
	115	155	13	110	19	Self	2360

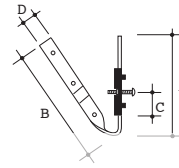

Size (mm)	A	B	C (min)	C (max)	Colour	Code
TOP RAFTER BRACKET (ADJUSTABLE) - For connecting gutter support bracket and strap to top edge of open rafter end.						
For 2100 Crescent and 2200 Corniche						
	86	250	26	79	Self	2161
For 2300 Streamline, 2400 Rapidflow and 2500 Omega						
	115	250	26	104	Self	2361

DISCONTINUED



Size (mm)	A	B	C	D	E	Colour	Code
RISE AND FALL BRACKET (ADJUSTABLE) DRIVE IN BRACKET - To support gutter support bracket and strap where no fascia or rafters are available.							
For 2100 Crescent and 2200 Corniche							
	260	130	50	62	43	Self	2162
For 2300 Streamline, 2400 Rapidflow and 2500 Omega							
	275	152	83	93	57	Self	2362

Polypipe
Building Services



A	B	B	C	C	D	D	E	F	F	G	Code
(min)	(max)	(min)	(max)	(min)	(max)	(min)	(max)	(min)	(max)		
310	266	281	235	241	193	212	149	115	127	25	2265

SUPPORT STRAP (ALL SYSTEMS) - Provides support for gutter fittings (running outlets and joint brackets) where fitting to rafters is required - Self Coloured

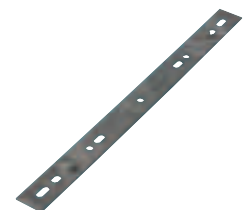
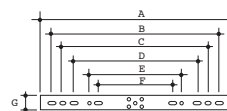

Rainwater Accessories

Rainwater Accessories

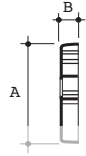

A	B	Colour	Code
SPACER BLOCK (STRAIGHT) - To increase stand-off distance of gutter support bracket. For 2100 Crescent and 2200 Corniche			
76	16	B	2166

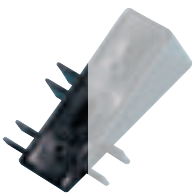

DISCONTINUED

A	B	Colour	Code
SPACER BLOCK (TAPERED) - To compensate for 22 1/2° of sloping fascia. For 2100 Crescent and 2200 Corniche			
76	33	B	2166.22

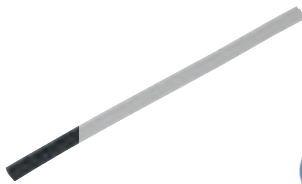

Polypipe

Colour	Code
GUTTER SEAL - Replacement seals for gutter fittings at connection points	
for 2100 Crescent	B 9911
for 2200 Corniche	B 9922
for 2300 Streamline and 2500 Omega	B 9933
for 2400 Rapidflow	B 9944

Building Services



Size (mm)	Colour	Code
GUTTER OUTLET GUARD - For placement over outlet aperture to reduce risk of downpipe blockages by leaves, other debris etc. Suitable for 68mm round and 62mm square outlets		
122	B	9915.25



Size (mm)	Colour	Code
ADAPTOR TO OTHER PVC-U GUTTERS - 2150 adaptor to all round rainwater systems		
110	Self	2167

Rainwater Accessories

Size (mm)	Colour	Code
ADAPTOR CLIP TO OTHER PVC-U GUTTERS - 2450 adaptor to all deepflow round systems		
131	Self	2467

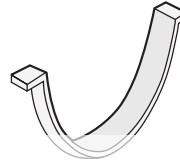

Size (mm)	L	Colour	Code
ADAPTOR TO UNDERGROUND DRAIN - For connecting 68mm downpipe to 82mm underground drain.			
68/82	54	B	3DW25



DISCONTINUED

Size (mm)	L	A	Colour	Code
ADAPTOR TO UNDERGROUND DRAIN - For connecting 68mm downpipe to 110mm underground drain				
68/110	54	10	B	4DW25

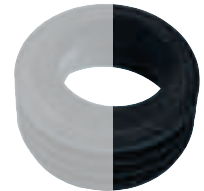

 **Polypipe**

Building Services

Size (mm)	L	Colour	Code
ADAPTOR TO UNDERGROUND DRAIN - Connects 62mm or 75mm downpipe to 110mm underground drain.			
62/110	54	B	4DW23

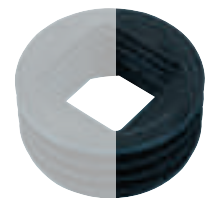

Size (mm)	L	Colour	Code
ADAPTOR TO UNDERGROUND DRAIN - Connects 82mm downpipe to 110mm underground drain			
82/110	54	B	4DW3



Size (mm)	L	Colour	Code
PIPE ADAPTOR 4" X 3" / 75MM SQ			
75/110	54	B	4DW33



Rainwater Accessories

Rainwater Accessories

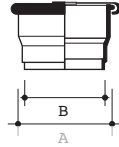

Size (mm)	A	B	Colour	Code
UNIVERSAL RAINWATER ADAPTOR - Connects 68mm or 62mm square downpipe to 110mm underground drain. Fits both pipe end and socket. Not for connection to foul drainage				
68/110	110	102	B	4D76



DISCONTINUED

Size (ml)	Description	Code
LIQUID WELD -		
125ml	Liquid Weld Tin Bs6209	9100.125
250ml	Liquid Weld Tin Bs6209	9100.250
500ml	Liquid Weld Tin Bs6209	9100.500



Polypipe

Building Services

Size (ml)	Description	Code
SOLVENT CLEANING FLUID -		
125ml	Solvent Cleaning Fluid	9101.125
250ml	Solvent Cleaning Fluid	9101.250



Size (ml)	Description	Code
LUBRICANT - For lubricating seal rings on expansion fittings		
250ml	Terrain Silicone Lubricant	9136.250
500ml	Terrain Soluble Lubricant	9136.500

Fixing & Connections

Fixing centres and expansion points

Thermal movement

When fixing gutter, allowance must be made for thermal movement and all Terrain outlets, angles and joint brackets are engraved with the appropriate expansion gaps. It is important that the gutter is correctly fitted into these fittings taking due care to place the cut end of the gutter on the line marked. It is important that the expansion gaps are maintained when gutter is fitted and must not be spaced to exceed 4 metres/13ft centres.

In the case of dry jointing downpipe each fitting clip has a sight hole provided on the front of it. (2113.25C, 2216.23 and the 82mm and 110mm fitting clips do not have sight holes.)

The purpose of the sight holes is to allow sight of the top of the pipe being fitted from below. When this pipe end obscures half of the aperture you have the correct expansion gap. The maximum distance between expansion joints should not exceed 5.5 metres/18ft.

Applicable to: all Terrain gutter systems and downpipe assemblies

Maximum distance between:

Gutter support brackets*:	1 metre*
Gutter expansion joints:	4 metres
Pipe fixing clips:	2 metres
Pipe expansion joints:	5.5 metres

***NOTE:** Support centres for gutters subject to risk of heavy snow fall should be reduced to 800mm (max).

For roof outlets

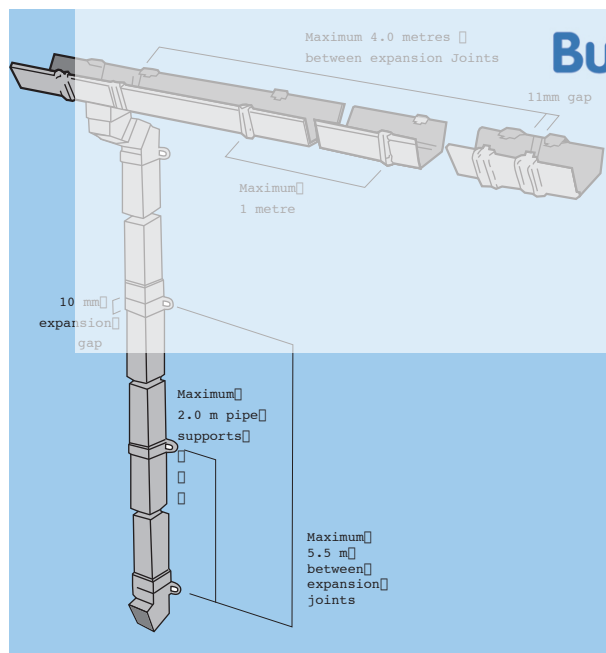

Fig. 1

For roof outlets

Application range:



Applicable to: 82mm and 110mm round pipework used with roof outlets.

Maximum distance between:

Vertical pipe fixing clips:	2 metres
Pipe expansion joints:	4 metres

†NOTE: Anchor expansion couplings with 140 Pipe Fixing Clip to prevent thermal expansion upthrust from rupturing joint between roof outlet and finish

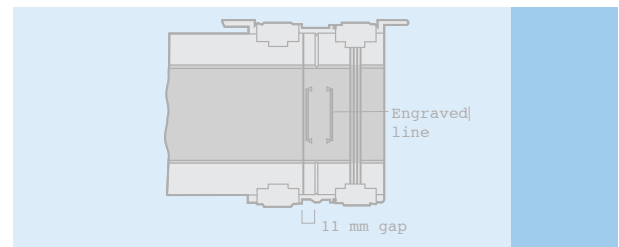

Fig. 2

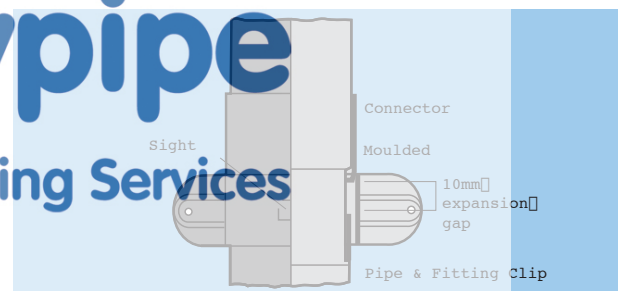

Fig. 3

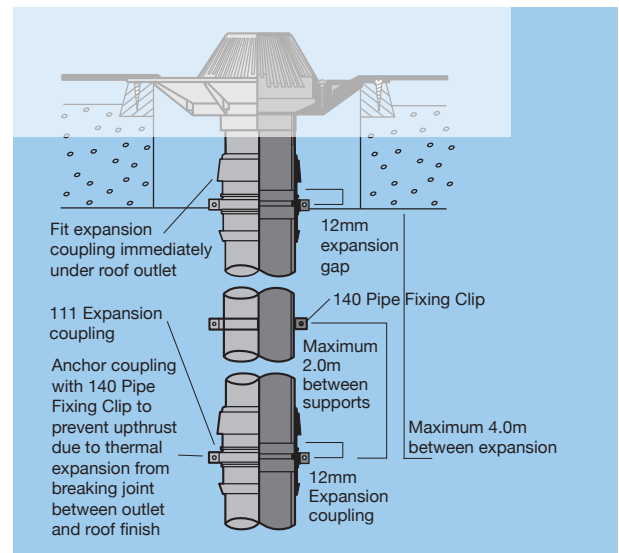

Fig. 4

DISCONTINUED

Polypipe Building Services

System Planning

Design principles

Sizing of rainwater installations

There is an approved BS EN method for the calculation of roof flow load, and the following general guidelines and assumptions on sizing of rainwater installations are based on this. For detailed guidance on a particular project, please refer to 'BS EN 12056-3:2000 Gravity Drainage Systems Inside Buildings – Roof Drainage, Layout and Calculations', or contact Terrain Technical Services on 01622 795200.

Rainfall

In the UK, it is generally satisfactory for eaves gutters to be designed for a rainfall intensity of 75mm/hr. The predicted frequency of storms producing intensities of 75mm/hr is low, with just one 2 minute duration fall of such intensity anticipated each year.

A good factor of safety is therefore built into any design using these values. However, when designing for closed areas such as lightwells, flat roofs or similar the rainfall intensity value allowed for should be increased. Again, please refer to 'BS EN 12056-3:2000'.

Snow

The following should be taken into account when designing guttering systems when snow loads are common or likely.

British Standards BS EN 12056-3:2000

Section NB4 states:

Gutter designed for rainfall will have adequate flow capacity for the removal of melting snow. However, gutters and outlets can become blocked by frozen snow but this can be avoided by the use of trace heating or snow boards.

Snow guards may be fitted to the eaves of a pitched roof where sliding snow may cause injury to people or damage to structures below. Depending upon what is at risk, snow guards can be necessary for roof pitches up to 60° from the horizontal and they need not be higher than 300mm for most situations. The fixings should be strong enough to withstand the forces calculated in accordance with BS 639903.

Section 7.2.2 states:

In areas where snow lies on roofs, the front edge of the gutter should not be higher than the projected line of the roof, unless snow guards or other precautions are used.

Terrain recommends that in designs where snow is likely, the gutter support brackets should be fixed at maximum of 800mm centres. In areas of high risk of snow Terrain recommends the use of snow guards or other protection.

Wind

There is no requirement to allow for the effect of wind when designing a rainwater system for flat roofs or roofs protected from the wind by adjacent buildings. However, the wind and the roof slope can have the effect of increasing the roof flow load for unprotected pitched roofs. This is allowed for in the 'BS EN 12056-3:2000' calculation method by adding half the rise to the roof span.

Roof Flow Load: How to calculate it

There are two factors to consider when calculating flow. Firstly the area to be drained, or 'effective roof area'; and the intensity of rainfall.

For the intensity of rainfall you should assume 75mm/hr except for enclosed areas such as lightwells and flat roofs.

Effective Roof Area

Effective Roof Area can be calculated using the following formula, as illustrated in Fig.5.

$ERA(m^2) = (W + H/2) \times L$ (Fig.5)

KEY:

ERA = Effective Roof Area (square metres)

W = horizontal distance from eaves to point directly below ridge

H = vertical rise between eaves and ridge (metres)

L = gutter length (metres)

Calculating the actual flow

Once you have calculated the ERA, for 75mm/hr rainfall intensity

$FLOW (litres/second) = ERA (m^2) \times 0.0208$

For other rainfall intensities

$FLOW = ERA (m^2) \times \text{rainfall intensity (mm/hr)} / 3600 = \text{litres/second}$

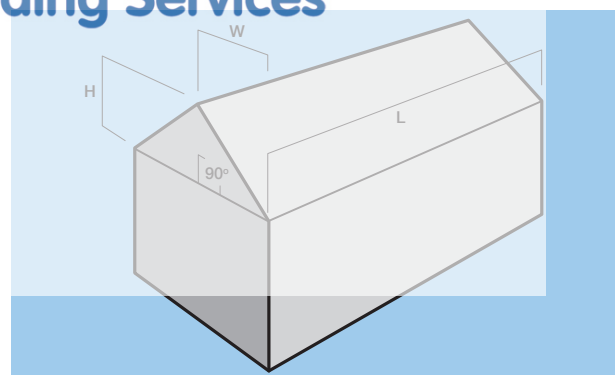

Fig. 5

DISCONTINUED



Polypipe
Building Services

Flow load calculations

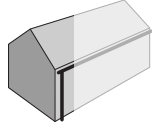
	Downpipe	Level Gutter		Gutter 1:350 fall	
	Size/Type (mm)	Area (m ²)	Flow (l/s)	Area (m ²)	Flow (l/s)
	Position A				
	2100 Crescent				
	68 round	46	0.96	61	1.27
	2200 Corniche				
	62 square	53	1.10	72	1.50
	2300 Streamline				
	75 Square 82 and 100 round	123	2.56	147	3.06
	2400 Rapidflow				
	68 & 82 round	105	2.19	133	2.77
	2500 Omega				
62 square 68 round	96	2.00	121	2.52	

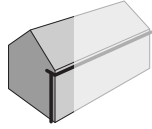
	Downpipe	Level Gutter		Gutter 1:350 fall	
	Size/Type (mm)	Area (m ²)	Flow (l/s)	Area (m ²)	Flow (l/s)
	Position B				
	2100 Crescent				
	68 round	37	0.77	49	1.02
	2200 Corniche				
	62 square	42	0.87	58	1.21
	2300 Streamline				
	75 Square 82 and 100 round	103	2.14	123	2.56
	2400 Rapidflow				
	68 & 82 round	86	1.79	109	2.27
	2500 Omega				
62 square 68 round	77	1.60	97	2.02	

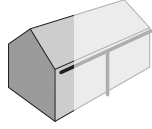
	Downpipe	Level Gutter		Gutter 1:350 fall	
	Size/Type (mm)	Area (m ²)	Flow (l/s)	Area (m ²)	Flow (l/s)
	Position C				
	2100 Crescent				
	68 round	92	1.91	122	2.51
	2200 Corniche				
	62 square	113	2.36	149	3.11
	2300 Streamline				
	75 Square	241	5.02	286	5.96
	82 round	242	5.04	286	5.96
	110 round	242	5.04	294	6.11
	2400 Rapidflow				
68 & 82 round	210	4.38	266	5.53	
2500 Omega					
62 square 68 round	192	4.00	242	5.04	

Roof outlets flow data

The flow rates listed have been established by independent testing carried out by the Rainwater Drainage Design Company using facilities at the Hydraulics laboratory of Salford University.

Roof outlet part no.	Size	Flow capacity litres/sec Head of water at outlet		
		30mm	50mm	100mm
2180.2	50	0.88	1.18	1.78
2180.3	82	2.12	2.52	3.21
2181.2	50	2.00	2.27	2.69
2181.3	82	2.10	4.89	7.22
2170.3	82	9.18	11.08	13.67
2170.4	110	9.29	14.11	18.22
2171.3	82	4.94	9.24	16.64
2171.4	110	5.17	9.95	24.18

Note: Figures based on 75mm/hr rainfall intensity

DISCONTINUED

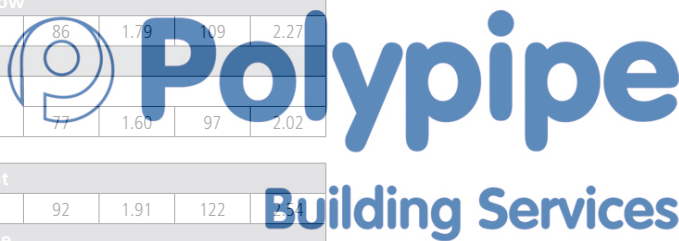
 Polypipe Building Services

Roof outlet flow load: calculation method

For a flat roof (i.e. a roof with a pitch less than 10°), the effective roof area = the plan area of the relevant part of the roof.

To calculate flow in litres/second for 75mm/hr rainfall intensity: firstly measure plan area of roof served by each outlet (square metres) and then multiply area by 0.0208 to obtain flow (litres/second)

NOTE: See Code of Practice BS EN 12056-3:2000 for full details

General Principles

Good Site Practice - Handling

- Take all reasonable care when handling PVC-u, particularly in very cold conditions.
- Load and unload loose pipes by hand.
- In case of mechanical handling, avoid the use of chains and hooks.

On site storage

- Stack pipe lengths:
 - either on a flat base
 - or on level ground
 - or on 75mm x 75mm timber at 1m maximum centres.
- Provide side support with 75mm wide battens at 1m centres (see Fig.6).
- Maximum stack: seven layers high.
- Ideally, stacks should contain one diameter pipe size only. Where this is *not possible*, stack largest diameter pipes at base of stack. Small pipes may be nested inside larger pipes.
- If stored in the open for long periods or exposed to strong sunlight, cover the stack with opaque sheeting.
- Store fittings under cover. Do not remove from cartons or packaging until required.
- Gutters should be kept under similar storage conditions, but additional care should be taken to protect the profile.
- Store solvent cement and cleaning fluid in a cool place out of direct sunlight and away from any heat source.

DISCONTINUED

Polypipe

Building Services

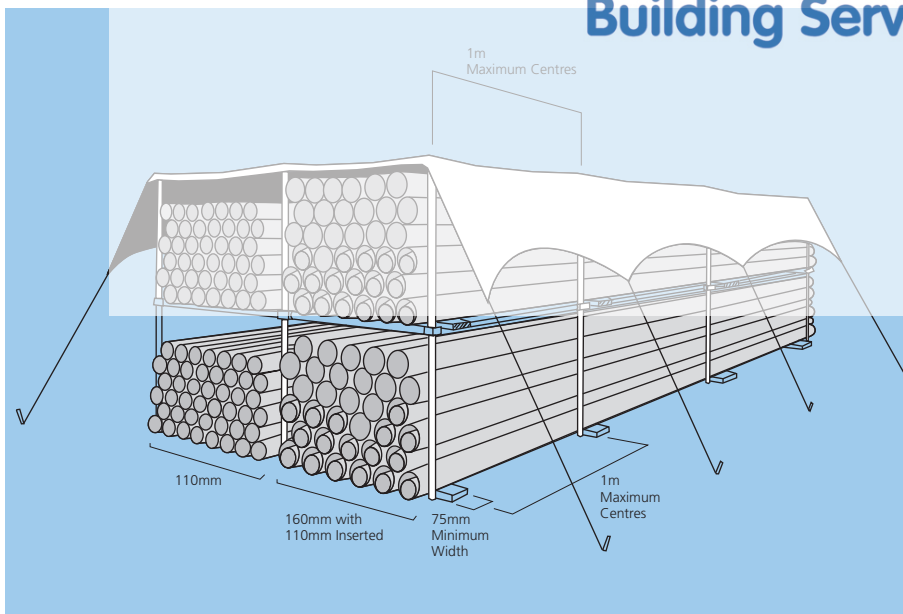

Fig. 6

Gutter Installation

Gutter Installation

General principle

Applicable to: all Terrain gutter systems

- Lock back clips of fittings in position and screw fitting to fascia where applicable
- Locate back of gutter under rear clip ensuring that the expansion gap is correct (see page 2)
- Pull front of gutter down and push front clip into position. To release gutter for adjustment, pull on tab at front of fitting

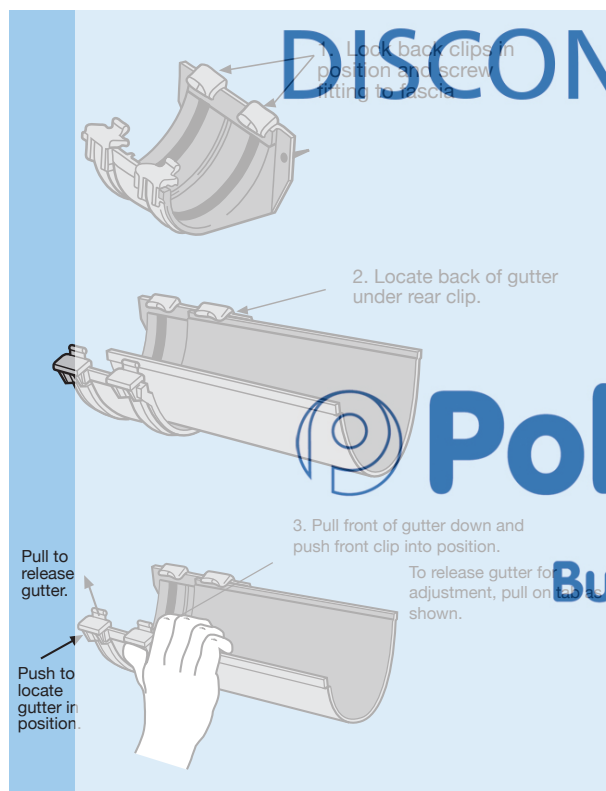

Fig. 7

Connecting to other gutter systems

Application Range

Crescent



Rapidflow



Applicable to: 2100 CRESCENT and 2400 RAPIDFLOW

- Gutter Adaptor Clips (2167.4 for 2100 CRESCENT, 2467.5 for 2400 RAPIDFLOW) permit connection between Terrain systems and PVC-u guttering of a similar design from other manufacturers
- Remove front locking clip from the side of Terrain fitting which is to take the connection, BUT DO NOT DISCARD
- Lay the other manufacturer's gutter into the fitting, ensuring that it sits correctly within the fitting and that the expansion gap is correct
- Insert one end of the Adaptor Clip under the back locking clip
- Holding the adaptor clip in position, re-insert the front locking clip
- Check that the gutter is fully seated within the fixing clip
- Push the front of the Adaptor Clip down onto the locking clip seat

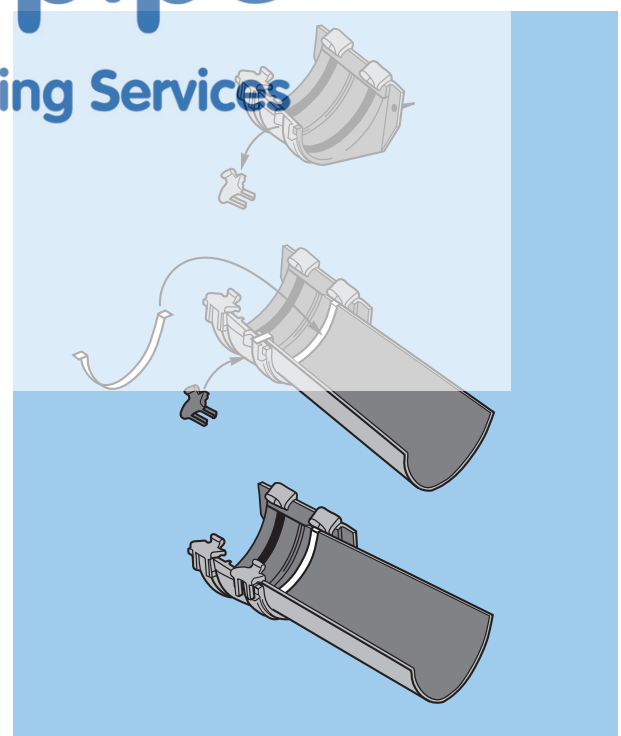

Fig. 8 2400 RAPIDFLOW system

Gutter Installation

Fixing principles

Secure fixing: screw specification

Applicable to: all Terrain gutter systems

- All Terrain gutter systems are designed to withstand maximum anticipated loading (e.g. heavy snow) without breaking
- Any method of fixing the gutter system to the building fabric MUST be equally capable of bearing such loading
- Assuming fixing to nominal 25mm thick softwood, fascia screws should be:
 - Size: No.10 roundhead* zinc-plated
 - Length: penetrating wood by minimum 19mm

*Some fittings are manufactured with countersunk holes (Omega). In such cases countersunk screws may be used

Fixing methods

Applicable to: all Terrain gutter systems

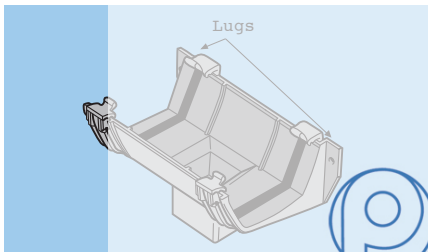

Fig.9a 2200 CORNICHE system

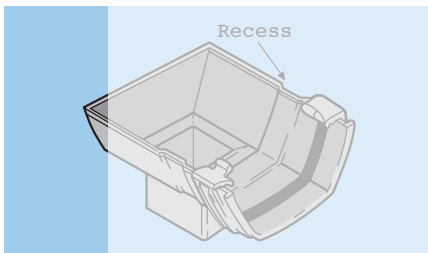

Fig.9b

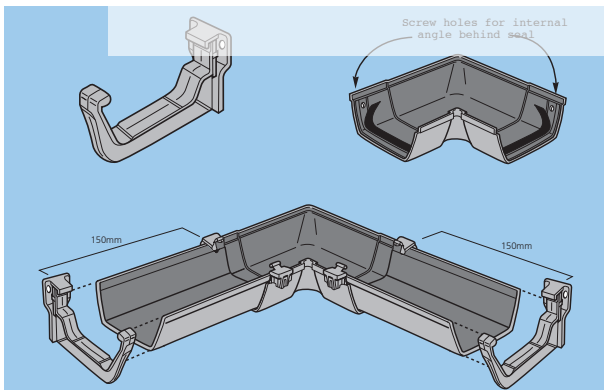

Fig.10

- Generally, Terrain gutter fittings (brackets, outlets, angles) are designed with:
 - EITHER integral fixing lugs (Fig.9a)
 - OR recess(es) (Fig.9b) which accept a standard support bracket

IMPORTANT NOTE: Whichever method is used, ALL fittings must be anchored

- In some cases, Terrain gutter fittings are designed with screw fixing holes behind the seal, eg gutter angle 2354.6.90. If it is not possible to secure gutter angles through the screw fixing holes, then support brackets must be fitted to the gutter within 150mm of the angle on both sides

Spacer blocks

Application range:



Applicable to: 2100 CRESCENT and 2200 CORNICHE systems

Designed to enable 2100 and 2200 systems to accommodate large tile overhangs, placing the gutter centrally beneath the tile edge. Avoids the need to use a larger gutter system. 2166 Spacer (rectangular): Steps out gutters by 16mm 2166.22 Spacer (triangular): Allows gutters to be fixed to 22 1/2° sloping fascias

- Screw fix spacer to fascia through fixing holes provided
- Fix bracket THROUGH spacer, solidly into fascia

Building Services

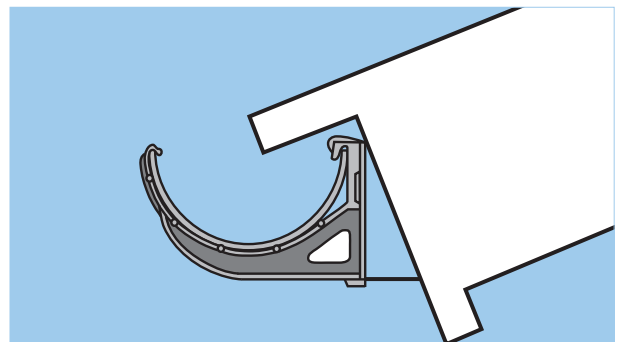
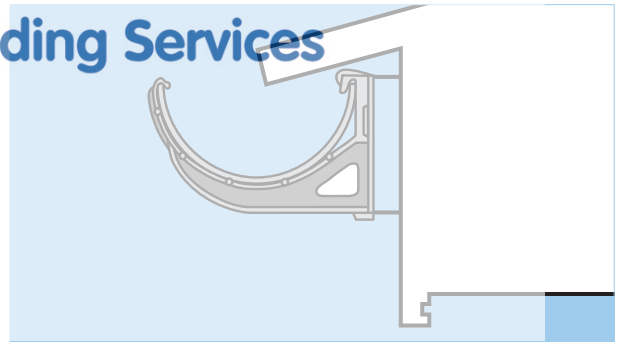

Fig.11

Fixing Brackets

Fixing adjustable rafter bracket

Applicable to: all Terrain gutter systems

- For fixing gutter systems to open-ended rafters where no fascia exists
NOTE: Only suitable for rafters in sound condition
- Choice of brackets (all adjustable):
Side (2160 and 2360)
Top (2161 and 2361)
- Fixing to rafter using (minimum) 2 x No.10 roundhead zinc-plated screws
- Support bracket secured by single bolt
- Pegs on rafter bracket locate in screw holes of support bracket

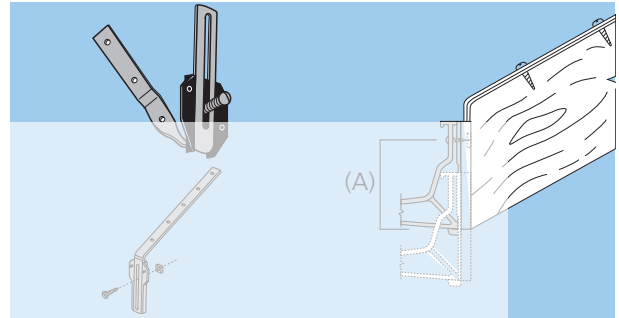

Fig.12

DISCONTINUED

System	Adjustment Range (A)
2100, 2200	65mm
2300, 2400, 2500	75mm

Support Strap



Polypipe

Support Strap

Gutter fitting support strap

Applicable to: all Terrain gutter systems

- For use with joint brackets and running outlets when used with any rafter bracket
- Discard PVC-u back plate from rafter bracket: retain nut and bolt to fix support strap to brackets
- Studs prevent support strap from twisting

Building Services

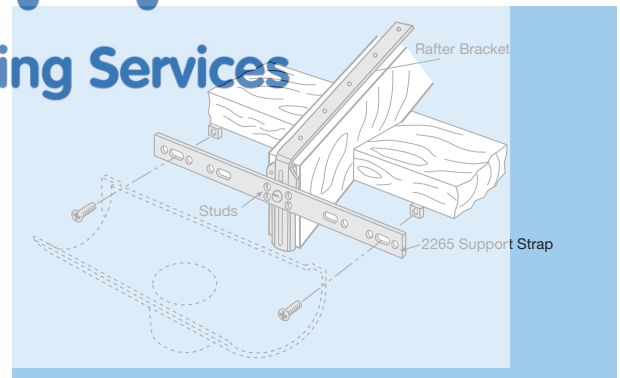

Fig.13

Gutter Installation

Drive-in Brackets

Drive-in brackets

Fixing drive-in brackets

Applicable to: all Terrain gutter systems

- For fixing gutters where no fascia board or rafters exist
- Standard version: 2162 (for 2100 CRESCENT and 2200 CORNICHE systems)
- Heavy duty version: 2362 (for 2300 STREAMLINE, 2400 RAPIDFLOW and 2500 OMEGA systems)
- Drive spike into mortar at appropriate height to allow fitting of gutter support bracket (or drill suitable hole and mortar spike in)
- Support bracket held in position by nut and bolt
- Adjust height by slackening locking nuts on threaded stud

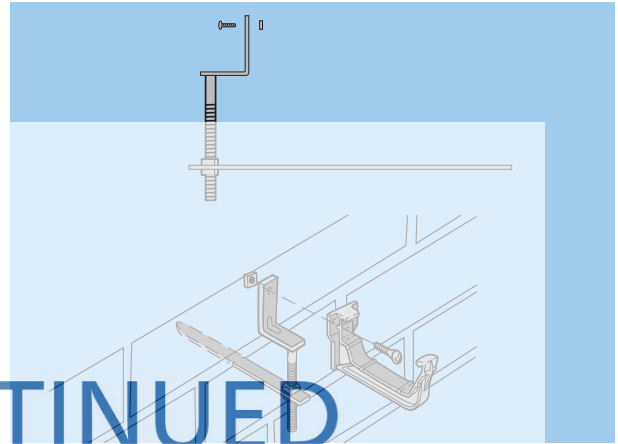

Fig.14

NOTE: If used on corbelled brickwork, ensure sufficient penetration of spike into mortar to support potential gutter loading

DISCONTINUED

 **Polypipe**
Building Services

Downpipe Installation

Offsets

- Form an offset (or 'swan neck') using 2 x 112.5° standard bends and a cut length of plain ended pipe

Small offsets

Application range:



Applicable to: 62mm and 75mm square downpipe systems

- For 62mm square downpipe, 2214.23 Wall Offset provides 25mm offset
- For 75mm square downpipe, 2314.33 Wall Offset provides 57mm offset

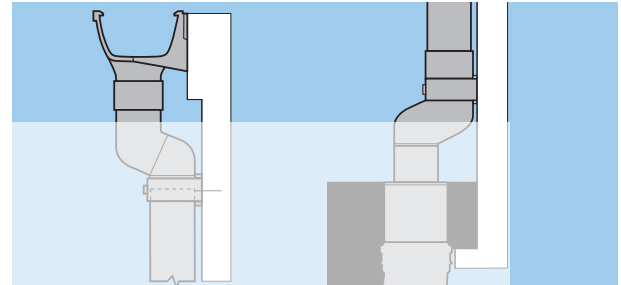

Fig.15

DISCONTINUED

Adjustable Pipe Clips

Adjustable pipe fitting clip (2112.25.T)

Application range:



Applicable to: 2100 CRESCENT, 2400 RAPIDFLOW and 2500 Omega, 68mm round downpipe

- Screw back plate to wall using No.10 roundhead screws
- Snap clip body around pipe or fitting. If around fitting, ensure it is located in the moulded groove
- Locate assembly over back plate and secure with nut and screw provided at required distance from wall

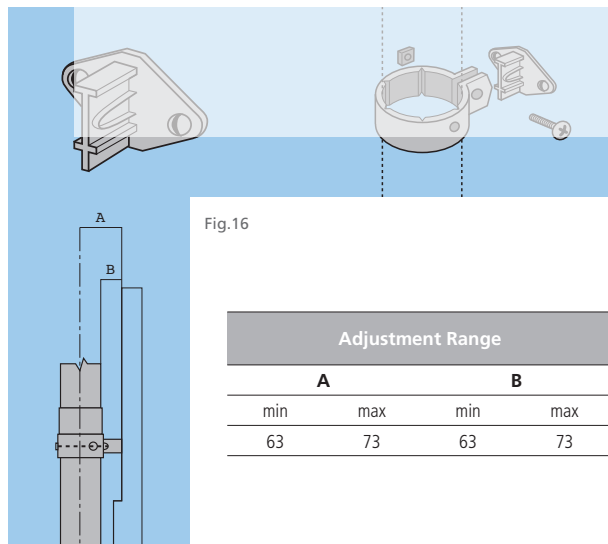

Fig.16

Adjustable pipe fitting clip (2212.23.T)

Application range:



Applicable to: 2200 CORNICHE and 2500 OMEGA, 62mm square downpipe

- Screw back plate to wall using No.10 roundhead screws
- Locate body over back plate. Ensure fixing nuts and screws are loosely fitted onto clip body (the screw thread should not fully penetrate the nut)
- Grip the screw heads firmly and locate onto the back plate
- Tighten fixing screws at required distance from wall

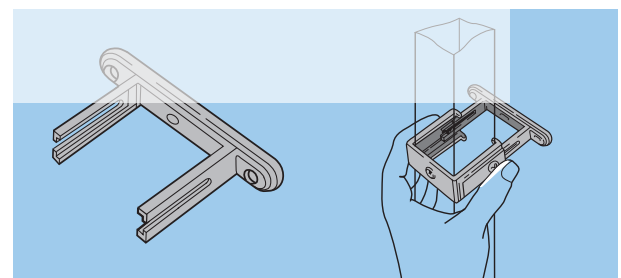

Fig.17

Downpipe Installation

Outlet Guard

Gutter outlet guard (9915.25)

Application range:



Applicable to: 68mm round and 62mm square downpipe

- Flexible polyethylene fitting designed to prevent leaves etc. entering the downpipe
- Push-fit into Stop End or Running Outlet

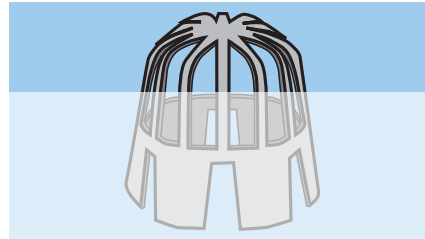

Fig.18

DISCONTINUED

Rainwater Shoes

Fixing and locking rainwater shoes

Application range:



Applicable to: 68mm round downpipe systems

- Locate the moulded nib on retaining grooves of shoes in one of the five retaining notches on 2112 or 2113 Fixing Clip
- Five different positions are possible. Each ensures both shoe and pipe above it are fully supported



Fig.17

Rainwater Heads

Applicable to: all Terrain Downpipes

- Direct push-fit connection at correct distance from wall (Fig.20a)
 - 2111.25 to suit 68mm round
 - 2211.23 to suit 62mm square
 - 2111.3 to suit 82mm round
 - 2111.4 to suit 110mm round
- Requires 25mm Offset Bend F2314.33.25 for connection to 75mm square downpipe at correct distance from wall (Fig.20b)
 - 2311.33 to suit 75mm square

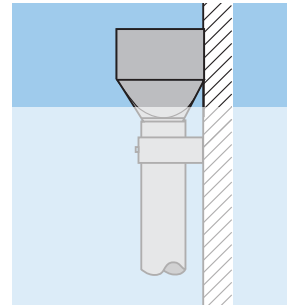

Fig.20a

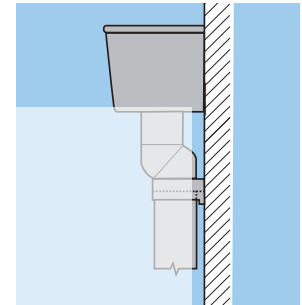

Fig.20b

DISCONTINUED

Connection to Buried Pipes

Connection to buried pipes

Application range:



Applicable to: 68mm round and 62mm or 75mm square downpipe systems

- Use EPDM rubber drain adaptors to connect downpipes to 82mm and 110mm buried drains

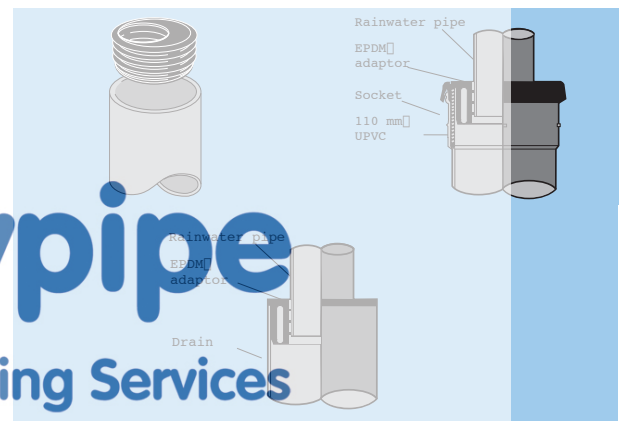

Fig.21

Outlet Adaptor

Screwed outlet adaptor (2368)

Application range:



Applicable to: 2300 Streamline with 75mm square downpipe

- Enables downpipe to be positioned anywhere along a gutter length
- Using Terrain Hole Cutter 2105.3 drill 76mm diameter hole in centre of base of gutter
- Unscrew the two parts of the adaptor and push top part with screw thread through hole in gutter outlet guard
- Screw the two parts of the adaptor together so that the gutter is clamped tightly

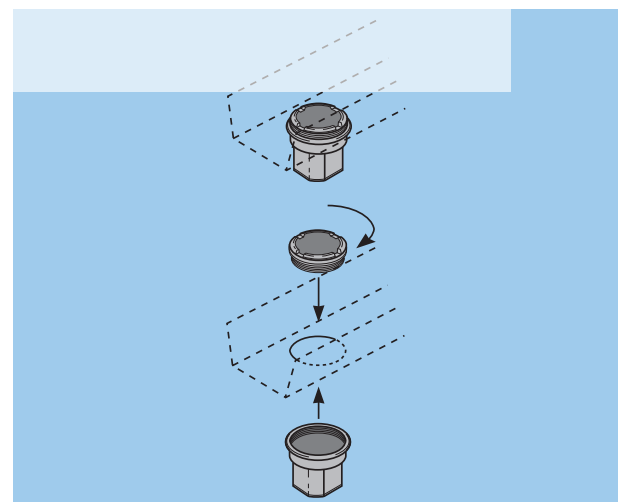

Fig.22

Downpipe Installation

Joining

Dry jointing

Application range:



Applicable to: Terrain 62mm/75mm square downpipe assemblies and 68mm/82mm round downpipe assemblies

- Fully support all downpipe and joint fittings with fixing clips positioned at correct intervals
- Install fittings with the socket facing upstream
- *NOTE: All downpipe fittings – except shoes – are socket/spigot*
- Ensure pipe ends are cut square and deburred before connection to fitting
- Position pipe and fitting clip in moulded groove on fitting
- Check clip is correctly positioned, by ensuring that the expansion gap is marked
- Use the sight hole in the front of the clip to achieve the correct expansion gap

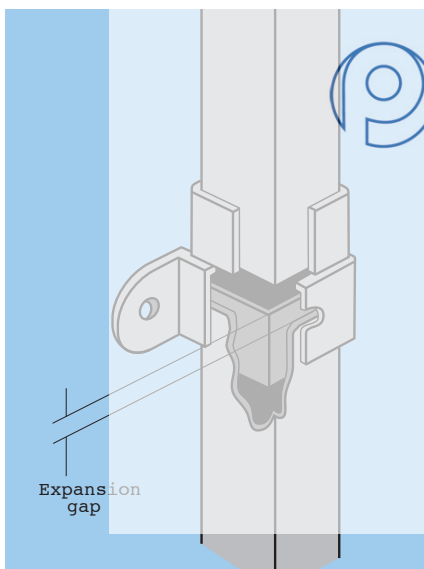

Fig.23 2200 CORNICHE system

Solvent cement jointing

Application range:



Applicable to: Terrain 110mm round downpipe assemblies

NOTE: The 2100.3 is a dry joint system for external use. If used internally, it must be solvent welded to make an air-tight system. Alternatively, the 100.3 soil system can be used.

- Cut pipe square, deburr and clean mating surfaces with 9101 Cleaning Fluid
- Coat mating surfaces with 9100 Liquid Weld, using a clean brush
- Assemble joint immediately, removing any excess cement with a clean rag

Initial set: 3-4 minutes

Final set: 12 hours

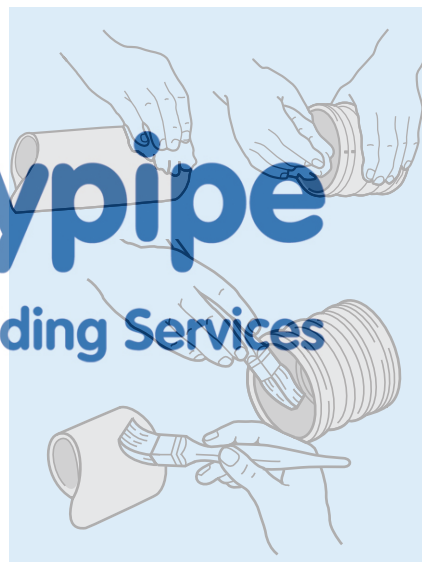

Fig.24

CAUTION: Closely follow directions for use of solvent cement as printed on the container label.

Joining

Seal ring jointing

Application range:



Applicable to: Terrain 110mm round downpipe assemblies

REQUIREMENT: To create a 12mm expansion gap at a pipe joint to allow pipes to expand without distorting the pipework

- File square cut pipe to provide 45° chamfer. (Do not chamfer to a knife edge.) Lubricate rubber seal with 9136 Lubricant
- Push pipe fully into socket. Mark pipe as shown (Fig.25)
- Withdraw pipe until mark is 12mm from socket to provide required expansion gap
- Anchor the expansion joint with a pipe fixing clip OR (if not practical) anchor a fitting within 1 metre of the joint

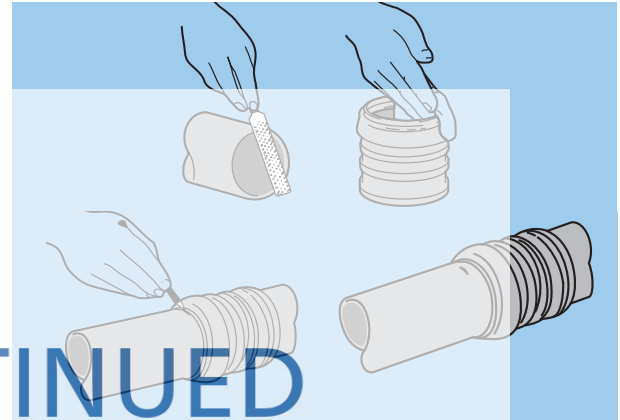

Fig.25

Conversion of solvent weld socket to ring seal joint

Application range:



Applicable to: 82mm and 110mm round solvent cemented downpipe assemblies, using 109.3/109.4 Seal Ring Adaptor

Under normal use fit 109 Adaptor to upstream socket only

- Clean mating surfaces with 9101 Cleaning Fluid
- Fit ring seal into 109 Collar
- Carefully apply solvent cement to mating surfaces
- Assemble immediately, applying firm even pressure until collar is correctly positioned



Fig.26

Balcony Outlet Installation

Balcony Outlets

Installing screed finish balcony outlet

Applicable to: 2172 Balcony Outlet

- Remove grid
- Position spacer on locating pegs
- Replace screws temporarily to prevent ingress of concrete
- Lay screed to the level of the top edge of the spacer
- Remove screws and replace grid
- Dress flashing over the rear upstand
- Tuck flashing into brickwork, joint and point

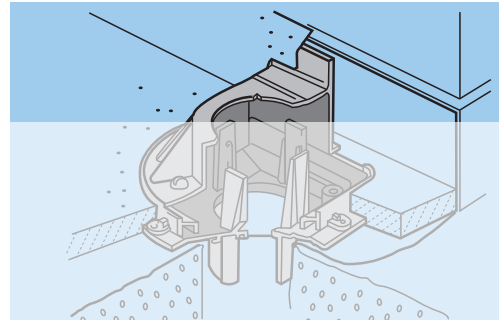

Fig.27

DISCONTINUED

Installing asphalt finish balcony outlet

Applicable to: 2174 Balcony Outlet

- Remove grid
- Temporarily replace screws to prevent ingress of asphalt
- Apply a suitable primer or bonding agent up to engraved line on outlet body
- Apply asphalt layer: dress over outer rim and down to engraved line on outlet body
- Remove screws
- Offer up grid and check correct angle of dressing
- Fit washer and grid, and secure with screws

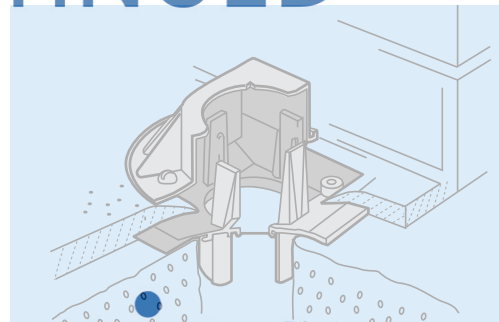

Fig.28

Polypipe

Building Services

NOTE: The polypropylene washer allows the grid to be easily removed for maintenance/clearing

Connection to downpipes

Applicable to: 2172 and 2174 Balcony Outlets

- For 68mm round downpipe (2100): use 2173.3.25 Socket Adaptor
- For 62mm square downpipe (2200): use 2273.3.23 Socket Adaptor
- For 82mm round downpipe (2100.3): connect direct to balcony outlet socket
- Solvent-weld all joints (see page 46)

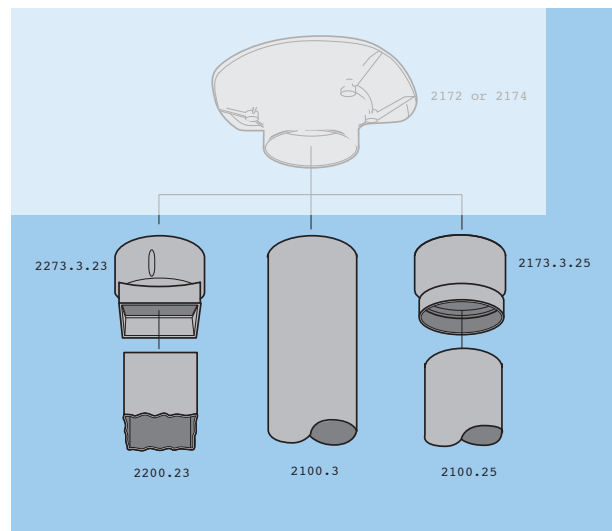

Fig.29

Small Roof Outlet Installation

Small Roof Outlets

Fixing small roof outlet to proprietary plastic finish

Applicable to: all 2180 and 2181 Roof Outlets

- Apply recommended adhesive to flange of outlet body
- Dress plastic material over flange to the edge of opening
- Secure the flat or domed grid with brass screw supplied, lightly clamping the roof finish material in position

Fixing small roof outlet to mineral felt finish

Applicable to: all 2180 and 2181 Roof Outlets

- Apply suitable bitumastic primer to flange of outlet body
- Apply liquid bitumen or activator to roof and prepared area of flange
- Lay first layer of felt to edge of flange
- Dress second and third layers over the flange to the edge of the opening
- Secure the flat or domed grid with the brass screw supplied, lightly clamping the edge of the second and third layers of felt

NOTE: 2180 and 2181 outlets are not suitable for use with hot asphalt

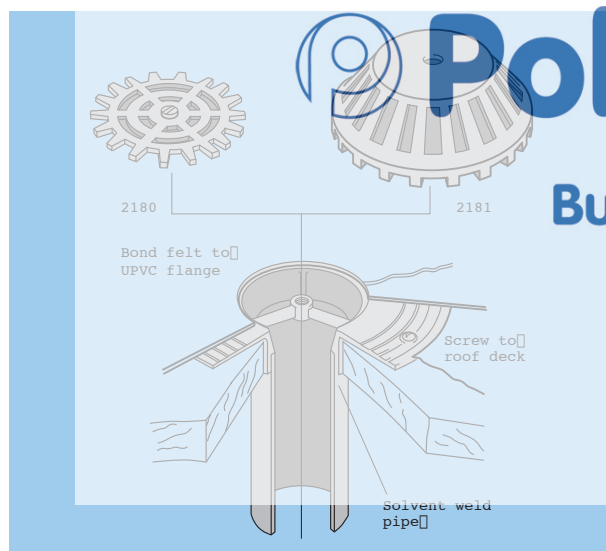

Fig.30

Connecting spigot/socket bends (small roof outlets)

Applicable to: all small diameter roof outlet

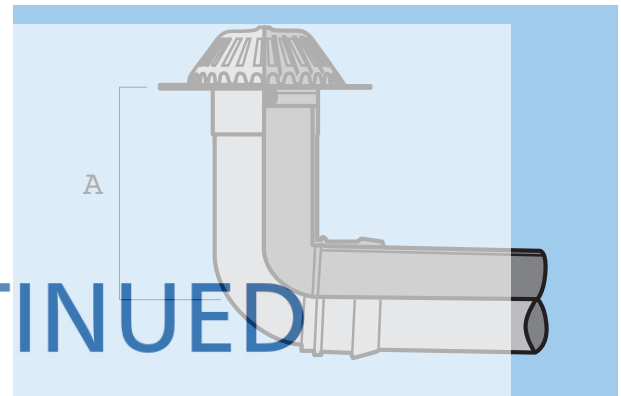

Fig.31 2181.2 Domed Outlet (small diameter)

Fittings	Outlet size (mm)	Dimension A (mm)	
		min	max
2180.2 + 207.2.92	55	73	118
2181.2 + 207.2.92	55	73	118
2180.3 + 107.3.92	82	89	168
2181.3 + 107.3.92	82	89	168

DISCONTINUED

Polypipe
Building Services

Large Roof Outlet Installation

Grid Options

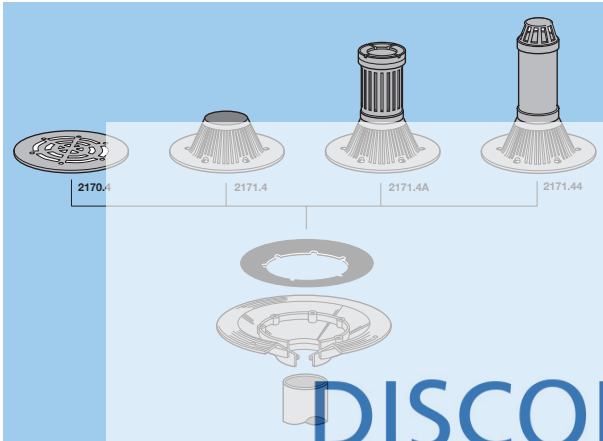

Fig.32

NOTE: 2170 flat roof outlet is not suitable for vehicular traffic

Fixing to asphalt finish

Applicable to: all 2170 and 2171 Roof Outlets

- Apply suitable bitumastic primer or bonding agent to bowl and flange of outlet body
- Dress a 19mm layer of asphalt over flange and bowl to level of upstand
- Offer up selected grid (see Fig.32 for alternative grids) check correct angle of dressing and engagement of screws
- Secure grid and washer in position with screws supplied

NOTE: The polypropylene washer allows the grid to be easily removed for maintenance/clearing

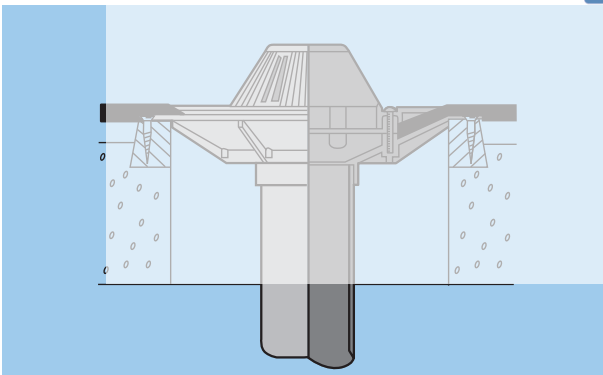

Fig.33 2171.4 Domed Outlet

Fixing to mineral felt finish

Applicable to: all 2170 and 2171 Roof Outlets

- Apply suitable bitumastic primer or bonding agent to bowl and flange of outlet body
- Apply liquid bitumen or activator to roof and prepared areas of outlet body
- Lay first layer of felt to edge of flange
- Lay second and third layers over roof outlet
- Dress down into bowl to the upstand
- Secure grid and washer in position with screws supplied

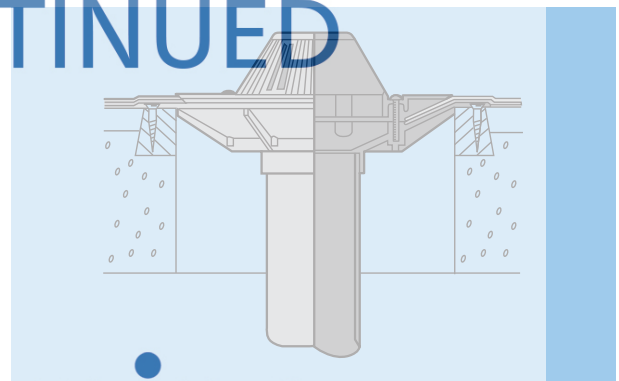

Fig.34 2171.4 Domed Outlet

Fixing to proprietary plastic finish

Applicable to: all 2170 and 2171 Roof Outlets

- Apply recommended adhesive to bowl and flange of outlet body
- Lay plastic material over roof outlet
- Dress over flange and bowl to the level of the upstand
- Secure grid and washer with screws supplied (see Fig.32 for alternative grids)

NOTE: The polypropylene washer allows the grid to be easily removed for maintenance/clearing

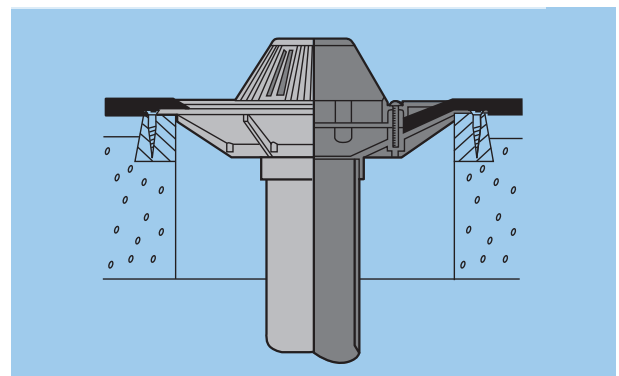

Fig.35 2171.4 Domed Outlet

DISCONTINUED

Polypipe
Building Services

Large Roof Outlets

Anchoring on thin or uneven roof structures

Applicable to: all 2170 and 2171 Roof Outlets

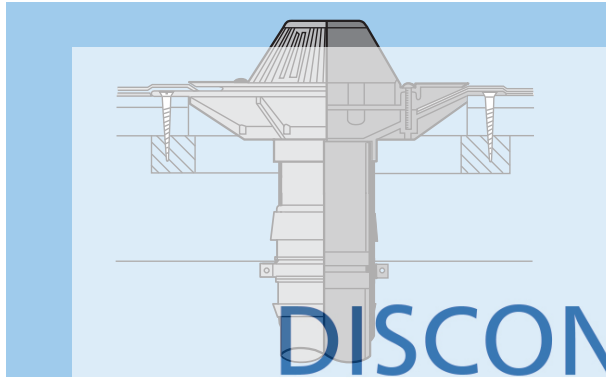

Three-layer felt on insulation material over profiled metal decking

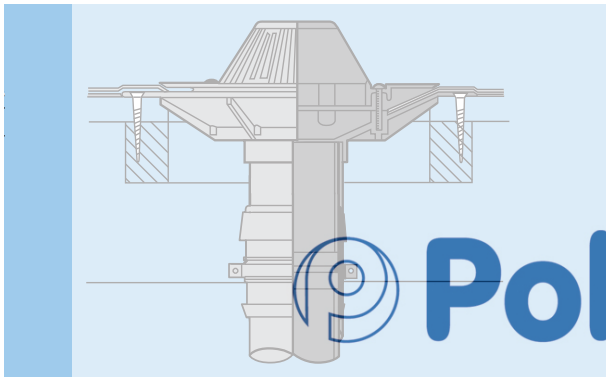

Three-layer felt on thin timber decking

Connecting spigot/socket bends (large roof outlets)

Applicable to: all large roof outlets

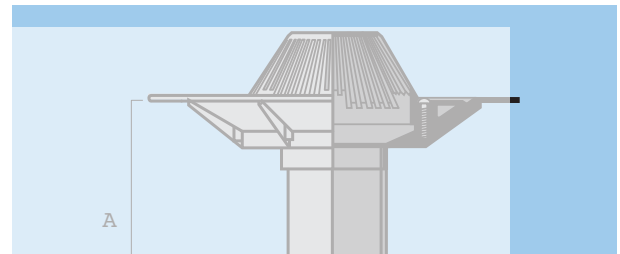

Fig.37 2171.4 Domed Outlet

Fittings	Outlet size (mm)	Dimension A (mm)	
		min	max
2170.3 + 107.3.92	82	140	219
2171.3 + 107.3.92	82	140	219
2170.4 + 107.4.92	110	146	257
2171.4 + 107.4.92	110	146	257

General fixing details

Applicable to: balcony and roof outlets

- Solvent weld pipe end, or spigot of bend, to roof outlet (for joining techniques, see page 46)
- Locate outlet body in roof structure and check that a suitable rigid fixing can be made
- Screw down outlet firmly to roof structure
- Remove grid
- Apply selected roof finish

Helping you solve problems

Terrain products are backed by a comprehensive Technical Advisory Service, which is here to provide you with advice and design guidance on all aspects of above and below ground drainage. Telephone 01622 795200 Fax 01622 716796.

Planning and development stage

The technical services available to help you at this stage include:

- Drainage system design, including detailed drawings
- Specification, product scheduling and estimating
- Design and production of bespoke fittings to meet specific application requirements
- NBS Specification clauses available

The Terrain Fabrication Service helps specifiers and contractors overcome problems both at the design stage, and on site. The Service can provide solutions to even the most demanding problems by fabricating special components to order.

Quality and assurance

Terrain is accredited to BS EN ISO 9001:2000 Management Systems. All systems are manufactured to the relevant European Standard and where applicable certified to British Standard.

- EN 607 Eaves Gutters and Fittings made from PVC-u
- EN 1462 Brackets for Eaves Gutters
- EN 12200 Plastic rainwater piping for above ground external use PVC-u

Index

CODE	DESCRIPTION	PAGE NO.
100.4.30	110MM DOWNPIPE - 3.0M	13
100.4.40	110MM DOWNPIPE - 4.0M	13
101.4.92	SWEPT BEND - 92½	13
101.4.112	SWEPT BEND - 112½	13
101.4.135	SWEPT BEND - 135	13
103.4.92	ACCESS BEND (DOUBLE SOCKET)	13
104.4.92	BRANCH (ALL SOCKET) - 92½	13
104.4.135	BRANCH (ALL SOCKET) - 135	13
105.4.92	ACCESS BRANCH	13
107.4.135	SPIGOT BEND	13
107.4.92	SPIGOT BEND (LONG TAIL)	14
110.4	STRAIGHT COUPLER	14
111.4	EXPANSION COUPLER	14
138.4	ACCESS PIPE	15
139.4	ACCESS PIPE	15
143.3	ONE-PIECE DOWNPIPE BRACKET	12
143.4	ONE-PIECE DOWNPIPE BRACKET	15
2100.25.30	68MM DOWNPIPE 3.0M	8
2100.25.40	68MM DOWNPIPE 4.0M	8
2100.25.55	68MM DOWNPIPE 5.0M	8
2100.3.40	82MM DOWNPIPE - 4.0M	11
2101.25.112	LONG RADIUS BEND	8
2101.3.92	SWEPT BEND - 92½	11
2101.3.112	SWEPT BEND - 112½	11
2101.3.135	SWEPT BEND - 135	11
2107.25	STRAIGHT COUPLER	8
2107.3	STRAIGHT COUPLER (DOUBLE SOCKET)	11
2108.25.92	SHORT BEND - 92½	8
2108.25.112	SHORT BEND - 112½	8
2109.25.92	BRANCH - 90	8
2109.25.112	BRANCH - 112½	8
2109.3.92	BRANCH (ALL SOCKET) - 92½	11
2109.3.112	BRANCH (ALL SOCKET) - 112½	11
2110.3	SHOE	11
2110.4	SHOE	14
2111.25	RAINWATER HEAD	9
2111.3	RAINWATER HEAD	12
2112.25.T	PIPE AND FITTING BRACKET (ADJUSTABLE)	9
2112.25.D	PIPE AND FITTING BRACKET (DRIVE-IN)	9
2113.25	PIPE FITTING CLIP	9
2113.25C	CENTRAL FIXING CLIP	9
2116.25	PIPE FITTING BRACKET	10
2137.25	ACCESS PIPE	10
2137.3	ACCESS PIPE	12
2150.4.40	CRESCENT GUTTER - 4.0M	20
2151.4	JOINT BRACKET	20
2152.4	SUPPORTING BRACKET	20
2153.4.25	RUNNING OUTLET	20
2154.4.90	GUTTER ANGLE - 90	20

CODE	DESCRIPTION	PAGE NO.
2154.4.120	GUTTER ANGLE - 120	20
2154.4.135	GUTTER ANGLE - 135	20
2154.4.156	GUTTER ANGLE - 156	20
2155.4	SHORT STOP-END	21
2156.4	INTERNAL STOP-END	21
2157.4.25	STOP END OUTLET	21
2158.4.45	CRESCENT TO 4½" CAST IRON SPIGOT	21
2159.4.45	CRESCENT TO 4½" CAST IRON SOCKET	21
2160	SIDE RAFTER BRACKET (ADJUSTABLE)	31
2161	TOP RAFTER BRACKET (ADJUSTABLE)	31
2162	RISE AND FALL BRACKET (ADJUSTABLE) DRIVE IN BRACKET	31
2166	SPACER BLOCK (STRAIGHT)	32
2166.22	SPACER BLOCK (TAPERED)	32
2167	ADAPTOR TO OTHER PVC-U GUTTERS	21
2167	ADAPTOR TO OTHER PVC-U GUTTERS	32
2168.4.45	CRESCENT TO 4½" OGEE CAST IRON SPIGOT	22
2169.4.45	CRESCENT TO 4½" OGEE CAST IRON SOCKET	22
2170.3	FLAT ROOF OUTLET (LARGE)	5
2170.4	FLAT ROOF OUTLET (LARGE)	5
2171.3	DOMED ROOF OUTLET (LARGE)	5
2171.4	DOMED ROOF OUTLET (LARGE)	5
2172.3	BALCONY OUTLET	6
2173.3.25	SOCKET ADAPTOR (82MM X 68MM)	6
2174.4A	INVERTED ROOF OUTLET	5
2174.4A	INVERTED ROOF OUTLET	5
2174.3	BALCONY OUTLET	6
2180.2	FLAT ROOF OUTLET (SMALL DIAMETER)	5
2180.3	FLAT ROOF OUTLET (SMALL DIAMETER)	5
2181.2	DOMED ROOF OUTLET (SMALL DIAMETER)	5
2181.3	DOMED ROOF OUTLET (SMALL DIAMETER)	5
2200.23.30	DOWNPIPE - 3.0M	16
2200.23.40	DOWNPIPE - 4.0M	16
2200.23.55	DOWNPIPE - 5.0M	16
2207.23	STRAIGHT CONNECTOR	16
2208.23.92	BEND - 92½	16
2208.23.112	BEND - 112½	16
2209.23.112	BRANCH	16
2210.23	SHOE	16
2211.23	RAINWATER HEAD	17
2212.23	PIPE AND FITTING BRACKET (ADJUSTABLE)	17
2213.23	PIPE AND FITTING BRACKET (ADJUSTABLE)	17
2214.23	WALL OFFSET	17
2215.23.25	ADAPTOR (SQUARE TO ROUND)	17
2216.23	LONG STAND-OFF DOWNPIPE BRACKET	17
2237.23	ACCESS PIPE	16
2250.5.40	CORNICHE GUTTER - 4M	23
2251.5	JOINT BRACKET	23
2252.5	SUPPORT BRACKET	23

DISCONTINUED



Polypipe

Building Services

CODE	DESCRIPTION	PAGE NO.
2253.5.23	RUNNING OUTLET	23
2254.5.90	GUTTER ANGLE - 90	24
2254.5.120	GUTTER ANGLE - 120	24
2254.5.135	GUTTER ANGLE - 135	24
2255.5	SHORT STOP-END	24
2257.5.23	STOP-END OUTLET	24
2265	SUPPORT STRAP (ALL SYSTEMS)	31
2273.3.25	SOCKET ADAPTOR (82MM X 62MM)	6
2300.33.40	DOWNPIPE - 4.0M	18
2307.33	STRAIGHT CONNECTOR	18
2308.33.112	BEND	18
2309.33.112	BRANCH	18
2310.33	SHOE	19
2311.33	RAINWATER HEAD	19
2313.33	PIPE AND FITTING BRACKET	19
2314.23	WALL OFFSET	19
2315.33.23	ADAPTOR (SQUARE TO SQUARE)	19
2337.33	ACCESS PIPE	19
2350.6.40	STREAMLINE GUTTER - 4.0M	25
2351.6.12	JOINT BRACKET	25
2352.6	SUPPORT BRACKET	25
2352.15	OVERSLUNG BRACKET	25
2353.6.33	RUNNING OUTLET - TO 75MM SQUARE DOWNPIPE	25
2353.6.3	RUNNING OUTLET - TO 82MM ROUND DOWNPIPE	25
2353.6.4	RUNNING OUTLET - TO 110MM ROUND DOWNPIPE	25
2354.6.90	GUTTER ANGLE - 90	26
2354.6.135	GUTTER ANGLE - 135	26
2355.6	SHORT STOP-END	26
2357.6.33WLH	STREAMLINE STOP END OUTLET LEFT HAND	26
2357.6.33WRH	STREAMLINE STOP END OUTLET RIGHT HAND	26
2360	SIDE RAFTER BRACKET (ADJUSTABLE)	31
2361	TOP RAFTER BRACKET (ADJUSTABLE)	31
2362	RISE AND FALL BRACKET (ADJUSTABLE) DRIVE IN BRACKET	31
2368.3	SCREWED OUTLET ADAPTOR	26
2450.5.40	RAPIDFLOW GUTTER - 4.0M	27
2451.5	JOINT BRACKET	27
2452.5	SUPPORT BRACKET	27
2453.5.25	RUNNING OUTLET - TO 68MM ROUND DOWNPIPE	27
2453.5.3	RUNNING OUTLET - TO 82MM ROUND DOWNPIPE	27
2454.5.90	GUTTER ANGLE - 90	27
2454.5.135	GUTTER ANGLE - 135	27
2455.5	SHORT STOP-END -	28
2457.5.25	STOP-END OUTLET - 82MM ROUND DOWNPIPE	28
2457.5.3	STOP-END OUTLET - 82MM ROUND DOWNPIPE	28
2467	ADAPTOR CLIP TO OTHER PVC-U GUTTERS	28
2467	ADAPTOR CLIP TO OTHER PVC-U GUTTERS	33
2550.5.40	OMEGA GUTTER - 4.0M	29
2551.5	JOINT BRACKET	29

CODE	DESCRIPTION	PAGE NO.
2552.5C	UNDERSLUNG SUPPORT BRACKET	29
2552.5	UNDERSLUNG SUPPORT BRACKET	29
2552.5.150	OVERSLUNG SUPPORT BRACKET	29
2553.5.25	RUNNING OUTLET	29
2554.5.90I	INTERNAL GUTTER ANGLE - 90	30
2554.5.135I	INTERNAL GUTTER ANGLE - 135	30
2554.5.90E	EXTERNAL GUTTER ANGLE - 90	30
2554.5.135E	EXTERNAL GUTTER ANGLE - 135	30
2555.5L	SHORT STOP-END (EXTERNAL) - LEFT	30
2555.5R	SHORT STOP-END (EXTERNAL) - RIGHT	30
2556.5L	INTERNAL STOP-END - LEFT	30
2556.5R	INTERNAL STOP-END - RIGHT	30
2557.5.25L	STOP-END OUTLET - LEFT	30
2557.5.25R	STOP-END OUTLET - RIGHT	30
9100.125	LIQUID WELD - 125ML	34
9100.250	LIQUID WELD - 250ML	34
9100.500	LIQUID WELD - 500ML	34
9101.125	SOLVENT CLEANING FLUID - 125ML	34
9101.250	SOLVENT CLEANING FLUID - 250ML	34
9136.250	TERRAIN SILICONE LUBRICANT	34
9136.500	TERRAIN SOLUBLE LUBRICANT	34
9911	GUTTER SEAL - FOR 2100 CRESCENT	32
9915.25	GUTTER OUTLET GUARD	32
9922	GUTTER SEAL - FOR 2200 CORNICHE	32
9933	GUTTER SEAL - FOR 2300 STREAMLINE AND 2500 OMEGA	32
9944	GUTTER SEAL - FOR 2400 RAPIDFLOW	32
9980	SPARE GRID FOR DOMED ROOF OUTLET -FOR 2171	7
9983	SPARE GRID FOR FLAT ROOF OUTLET -FOR 2170	7
9990	SPARE GRID FOR BALCONY OUTLET -FOR 2172	7
9995.3	CAP FOR BALCONY OUTLET	7
3DW25	ADAPTOR TO UNDERGROUND DRAIN	33
4D76	UNIVERSAL RAINWATER ADAPTOR	34
4DW23	ADAPTOR TO UNDERGROUND DRAIN	33
4DW25	ADAPTOR TO UNDERGROUND DRAIN	33
4DW3	ADAPTOR TO UNDERGROUND DRAIN	33
4DW33	PIPE ADAPTOR 4" X 3" / 75MM SQ	33
S2308.33.92	3X3"SQ S/LINE BEND	18
S2309.33.92	3X3"SQ S/LINE BRANCH	18

DISCONTINUED

Polypipe Building Services

DISCONTINUED



DISCONTINUED



Information in this publication must not be reproduced in whole or in part without the permission of Polypipe. The contents are given in good faith and no warranty is given or implied in respect of such information. Polypipe reserve the right to amend this specification without prior notice and all transactions are subject to our standard Conditions of Sale. © Polypipe and ® are registered Trademarks of Polypipe. All Polypipe products are protected by Design Right under CDPA 1988. Copyright © 2006 Polypipe. All rights reserved.

DISCONTINUED

Terrain Rainwater Systems



Polypipe

Building Services Polypipe Building Services

New Hythe Business Park
College Road
Aylesford
Kent
ME20 7PJ
United Kingdom
Tel: +44 (0)1622 795200
Fax: +44 (0)1622 716796



commercialenquiries@polypipe.com
www.polypipe.com/commercial-building-services